

Kinco FM Series Fieldbus Control Stepping Motor Drive



USER MANUAL

Kinco®	1
Chapter 1 Product Overview	8
1.1 Product Acceptance	8
1.2 Product Overview	8
1.3 Product Features	8
1.4 Product Weight	9
1.5 Product Model Description	9
1.5.1 FM860 Stepping Motor Drive	9
Chapter 2 Precautions and Installation Requirement	10
2.1 Precaution	10
2.1 Environment Conditions	10
2.2 Mounting Direction & Spacing	10
Chapter 3 Interfaces and Wirings	12
3.1 Appearance View	12
3.1.1 Interfaces of driver	12
3.1.2 The X1 and X2 LED definition of FM 860	13
3.2 DIP Switch	13
3.2.1 ID Setting up	13
3.2.2 Communication port Settings	13
3.3 I/O Wiring Diagram	14
3.4 Communication Connector	15
3.4.1 CAN	15
3.4.2 RS485	16
3.4.3 RS232	16
3.5 FM860 Connecting View	17
Chapter 4 Using Kinco Stepping PC Software Installing PC Software	18
4.1 Installing PC Software	18
4.2 Easy Using	18
4.2.1 Connecting a PC	18
4.2.2 How to use Kinco Stepping PC software	18
4.3 Operation Your Menu	22
4.4 How to control your Drive	23
4.4.1 The Drive Settings	23
4.4.2 Motor configuration	23
4.4.3 Current settings	24
4.4.4 Microstep settings	25
4.4.5 Basic Setting	25
4.4.6 I/O Port Settings	26
4.4.7 Data dictionary	27
4.4.8 ECAN Setting	29
4.4.9 Drive Property	30
4.4.10 Error Control	30

4.4.11	Error History	31
4.4.12	Initialize/Save	32
Chapter 5	Operating the I/O Port	33
5.1	Digital signal input	33
5.1.1	The Polarity control of digital input.....	33
5.1.2	Digital signal input address and function.....	34
5.1.3	Digital input both for NPN and PNP	36
5.2	Digital signal output	38
5.2.1	The Polarity control of Digital signal output	38
5.2.2	Digital signal output address and function.....	38
5.2.3	Digital output.....	39
5.3	Analog signal input.....	41
5.3.1	AIN1 common mode voltage input.....	41
5.3.2	AIN1 Differential mode voltage input.....	42
Chapter 6	Operating Mode	43
6.1	Profile position mode 1	43
6.2	Profile velocity mode 3.....	43
6.3	Pulse Control Mode -4.....	44
6.4	Homing Control Mode 6.....	45
6.5	How to simulate velocity mode 3	45
6.5.1	The index of velocity mode 3	45
6.5.2	The Process diagram of analog signal	46
6.5.3	How to simulate velocity mode 3 without dead zone voltage and offset.....	47
6.5.4	How to simulate velocity mode with dead zone voltage	47
6.5.5	How to simulate profile velocity mode with dead zone voltage and offset	48
6.6	Multi-target speed control mode 1	49
6.6.1	Multi-Target position control.....	49
6.7	Multi-speed 3.....	51
Chapter 7	Communication Function.....	53
7.1	RS232	53
7.1.1	RS232 Hardware.....	53
7.1.2	RS232 Parameters.....	53
7.1.3	Free transfer protocol.....	54
7.1.4	Data Protocol	54
7.1.5	RS232 Communication address.....	56
7.2	RS485	57
7.2.1	RS485 Communication port	57
7.2.2	RS485 Communication parameters	58
7.2.3	MODBUS RTU Communication Protocol	58
7.2.4	Modbus Function code	59
7.2.5	Modbus Communication address.....	61
7.3	CANopen Bus communication	61
7.3.1	Hardware introducing	62
7.3.2	CANopen Communication parameters	63
7.3.3	EDS.....	64
7.3.4	SDO	64
7.3.5	COB-ID	67
7.3.6	PDO:	68

7.3.7	Boot-up Process	69
7.3.8	NMT Module Control	70
7.3.9	Protection mode (Supervision Type)	71
7.3.10	CANopen Communication Address of Stepping Motor Drive Parameters.....	72
Chapter 8	Alarm and Troubleshooting	73
8.1	Alarm Messages.....	73
Chapter 9	Appendix.....	75
9.1	Appendix I CANopen Bus communication case.....	75
9.1.1	CANopen communication between FM860 and Kinco F1 PLC	75
9.1.2	CANopen Communication between FM860 and Peak CAN.....	82
9.2	Appendix II RS485 Communication Case.....	86
9.2.1	Modbus Communication between FM860 and KINCO HMI	86
9.2.2	Communication between FM860 and Modebus	88
9.2.3	Modbus Communication Between FM860 and Siemens S7-200	91
9.3	Appendix III RS232 Communication Case	93
9.3.1	Communication between FM860 and KINCO HMI.....	93
9.3.2	The Free Protocol Communication between FM860 and Adjustment tool of Serial port.....	94
9.3.3	Console wire	97
9.4	Appendix IV Homing Method.....	98
9.5	Appendix V Use Stepping Motor Drive PC software to read and write drive.....	101
9.6	Appendix VI Conversion between Engineering unit and internal unit of Common objects.....	107
9.7	Appendix VII Common Object List	107

Safety Precautions

For the sake of personal safety and avoidance of property loss, please read these safety precautions carefully before test running and use of the driver.

The following safety measures must be strictly followed:

- After being powered on, the voltage in side FM860 driver is about 70VDC max. The voltage still exists 30 seconds after the power supply is cut off. Before performing any wiring or check operation, use a multimeter to verify that the voltage on the driver terminals is safe; otherwise, the electric shock may occur..
- Never connect wires while the driver and the motor are working; otherwise, the electric shock may occur.
- Do not remove the housing of the driver when the power is on or the driver is working; otherwise, the electric shock may occur.
- To avoid personal injury and property loss, only qualified and service-trained personnel can operate the driver.
- Follow related technical specifications and electric installation standards during installation. The driver must be securely grounded with the cross section of the ground cable.
- Do not insert any object into the driver, which may cause damage to the equipment.
- If any fault occurs to the driver, please return the driver to the maintenance and repair center. Opening the driver without authorization or improper operation may cause damage to the driver. Removing the enclosure of the driver without authorization will void the warranty.
- The waste driver shall be disposed of as industrial waste to avoid environmental pollution.

Warn

- When this driver is applied in some mechanical instruments where personal safety is directly involved (e.g. nuclear power control, medical device, truck, train, airplane, amusement and safety devices), be sure to install proper fault-proof devices to avoid the possibility of personal injury.
- Electronic devices have the appropriate lifecycle. Adequate safety measures must be taken to ensure personal and equipment safety in case of a failure. The users must be liable for any loss resulting from equipment fault or misoperation of the driver.

Chapter 1 Product Overview

1.1 Product Acceptance

Upon receiving the product, please check the following items:

- Make sure the driver model is consistent with that ordered.
- Unpack the product and make sure it is free from damage and no part is missing.
- Make sure all set screws in the driver are securely tightened.
- Check the received product against the packing list and contact our customer service center in time if any part is missing.

Table1-1 Packing list

Packing List	
article	Qty
FM860 Stepping Motor Drive	1pcs
Services Directory	1pcs
FM860 Fieldbus Control Stepping Motor Driver Operating guide	1pcs
Certificate of Conformity	1pcs
SCSI 20P connector	1pcs
6P 5mm pitch size terminal block	1pcs
length 10mm diameter $\phi 10$ Insulated terminals	6pcs
length 15mm diameter $\phi 12$ Insulated terminals	6pcs
Console wiring (RS232 to RJ45)	1pcs

Note: The console wiring is optional product. If need it please contact our customer service center

1.2 Product Overview

FM860 is one of the new Stepping motor drive with field bus control. It cans driving two phase or three phase hybrid stepping motor. As for the heat sink, used new design style. The structure is small and exquisite, and also can meet CE standard requirement.

1.3 Product Features

- Power supply: 24~70VDC.
- Support drive two or three phase step motor, output current as 0.1- 6A peak
- 6 channels opto-isolation digital signal input, and 3 channels of them support wide voltage input as 5~24VDC
- 3 channels opto-isolation digital signal output, max current 100mA
- Single-channel analog signal input ($\pm 10V$) control the speed.
- Support multiple pulse input mode, PLS+DIR, CW/CCW and QEI.
- Support CANOpen and Modbus bus protocol control and optimize the customer's control circuitry.
- Multi IO configuration to adapt to different control modes.
- With motor parameter adaptive function, driving motor in the best performance.
- With the protection function of over-voltage, under-voltage, overheat and over-current.
- CAN and RS485 (Option), RS232

- Micro step : 0~128
- CE and RoHS

1.4 Product Weight

G.W:0.51kg, N.W:0.36 kg.

1.5 Product Model Description

1.5.1 FM860 Stepping Motor Drive

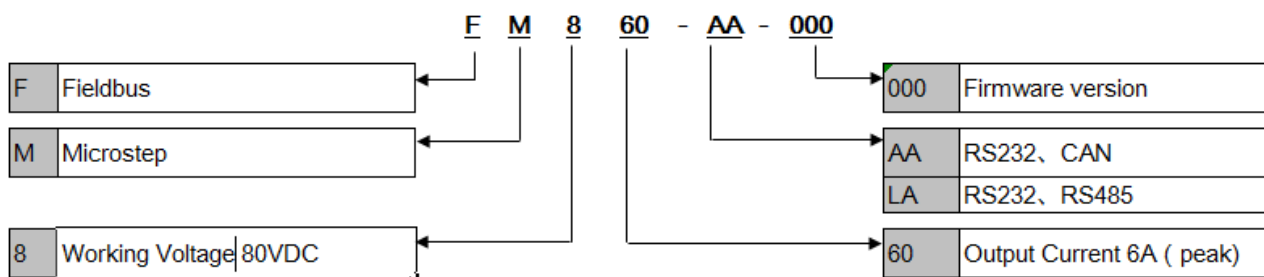

Figure 1-1 FM860 Naming rule

Chapter 2 Precautions and Installation Requirement

2.1 Precaution

- Tightly fasten the screws that fix the motor.
- Make sure to tightly fasten all fixed points when fixing the driver.
- Do not tighten the cables between the driver and the motor.
- Use a coupling shaft or expansion sleeve to ensure that both the motor shaft and equipment shaft are properly centered.
- Do not mix conductive materials (such as screws and metal filings) or combustible materials (such as oil) into the driver.
- Avoid the driver and stepper motor from dropping or striking because they are precision equipment.
- For safety, do not use any damaged driver or any driver with damaged parts.

2.1 Environment Conditions

Table 2-1 Environment requirement

Environment	Condition
Temperature	Operating temperature: 0°C ~ 40°C (Ice-free) Storage humidity: -10°C ~ 70°C (Ice-free)
Humidity	Operating humidity: < 90%RH (No condensation) Storage humidity: < 90%RH (No condensation)
Air	Indoor (No direct sunlight), no corrosive gas or combustible gas, no oil vapor or dust
Height	Below 1000m above the sea level
Vibration	5.9 m/s^2

2.2 Mounting Direction & Spacing

Please install the driver correctly according to following figure, or it will cause faults.

The driver should be vertically installed on wall. Take fully into account heat dissipation when using any heating components (such as braking resistors) so that the driver is not affected.

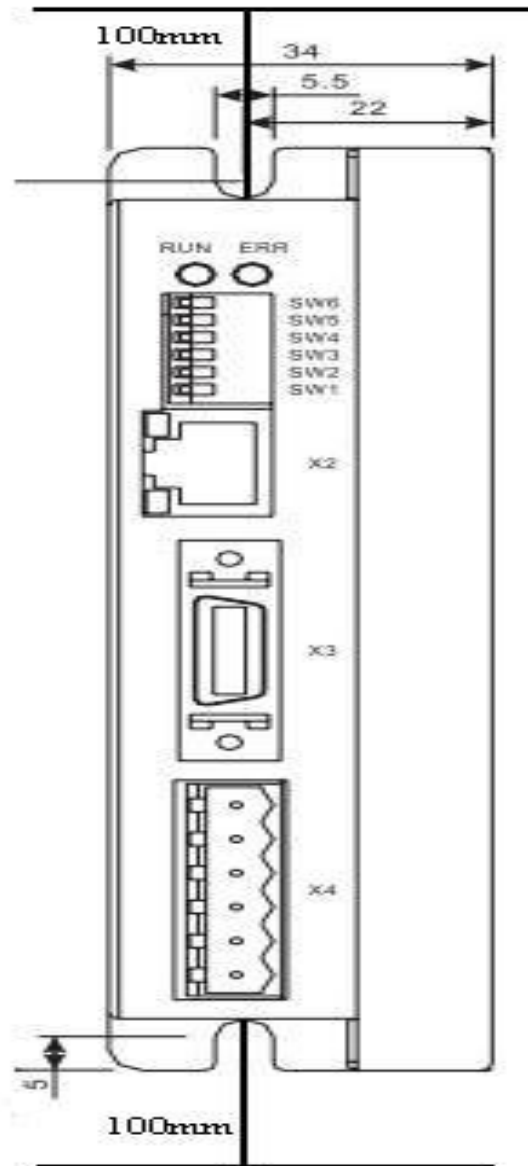

Figure 2-1 mounting direction

Chapter 3 Interfaces and Wirings

3.1 Appearance View

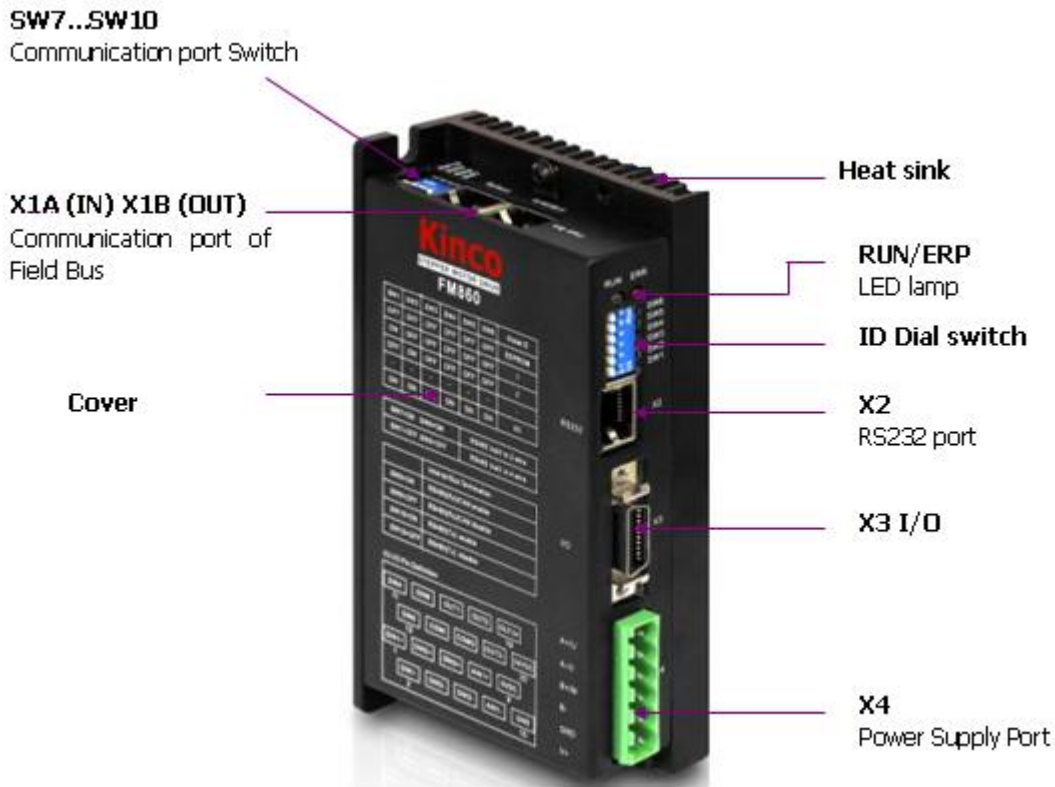

Figure 3-1 FM860 overview

3.1.1 Interfaces of driver

Table 3-1 Jacks introducing

Interface		Symbol	Function
Field Bus		SW7~SW10	Communication port Switch
		X1A(IN) X1B(OUT)	CAN Bus Or RS485 Bus interface
ID Switch		SW1~SW6	ID Switch
RS232		X2	RS232 interface
IO	DIN1+	X3	Digital signal input
	DIN1-		
	DIN2+		
	DIN2-		
	DIN3+		
	DIN3-		
	DIN4		
	DIN5		
DIN6			

	COMI		Analog signal input and logic voltage interface	
	AIN1+			
	AIN1-			
	GND			
	5VDC			
	24VDC			
	OUT1			Digital signal output
	OUT2			
	COMO			
	OUT3+			
	OUT3-			
Power supply and Motor wire connector	A+/U	X4	2 or 3 phase stepper motor cable interface	
	A-/V			
	B+/W			
	B-			
	GND		Power supply input DC24-70V	
	V+			

3.1.2 The X1 and X2 LED definition of FM 860

Table 3-2 The LED definition

Name	Color	Definition
X2	Green	Power instructions
	Orange	Receive RS232
X1	Green	Send instructions
	Orange	Receiving instructions

3.2 DIP Switch

3.2.1 ID Setting up

Table 3-3 DIP switch settings

SW1	SW2	SW3	SW4	SW5	SW6	Node ID
OFF	OFF	OFF	OFF	OFF	OFF	EEPROM
ON	OFF	OFF	OFF	OFF	OFF	1
OFF	ON	OFF	OFF	OFF	OFF	2
ON	ON	OFF	OFF	OFF	OFF	3
-	-	-	-	-	-	-
ON	ON	ON	ON	ON	ON	63

Note: Please use the PC software to set and save your parameters when Node-ID is bigger than 63, and all of switch have to be set as OFF. And use the value of EEPROM when it is power-on, but not in value of switch.

3.2.2 Communication port Settings

Table 3-4 communication port

SW7=ON, SW8=ON	RS485 2 wire MODBUS
----------------	---------------------

SW7=OFF, SW8=OFF	RS485 4 wire MODUS
------------------	--------------------

		DIP switch of termination resistors	
CAN bus		SW9=ON , SW10=OFF, Enable	SW9=OFF, SW10=OFF,Disable
RS485 bus	2 wires	SW9=ON , SW10=OFF,Enable	SW9=OFF, SW10=OFF,Disable
	4 wires	SW9=ON, SW10=ON,Enable	SW9=OFF, SW10=OFF,Disable

3.3 I/O Wiring Diagram

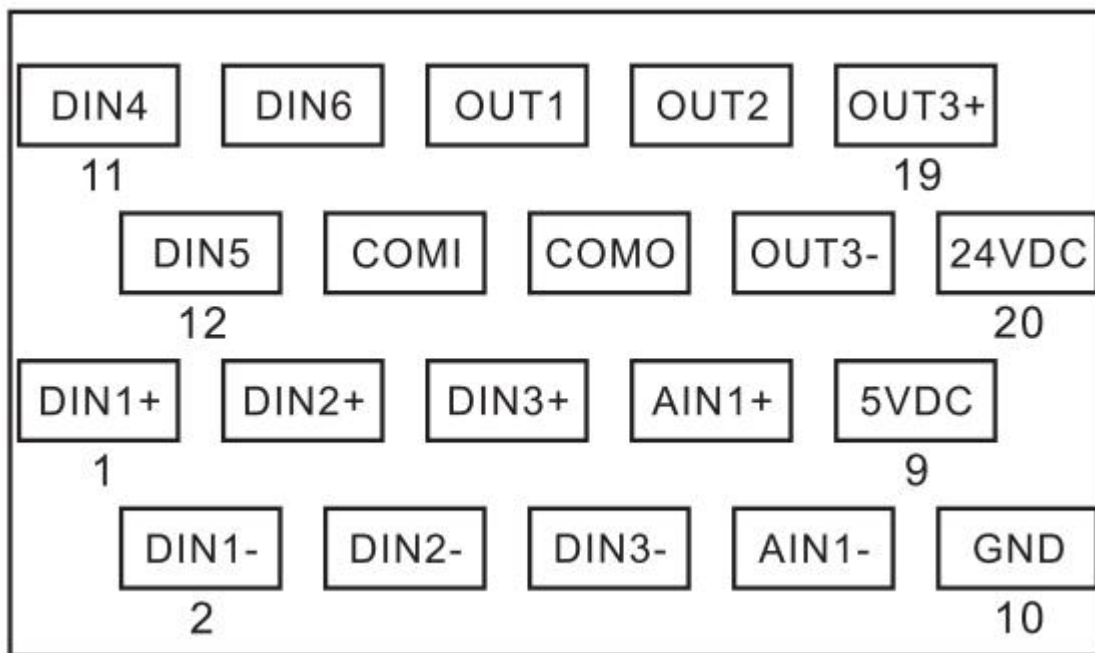

Figure 3-2 Wiring Diagram

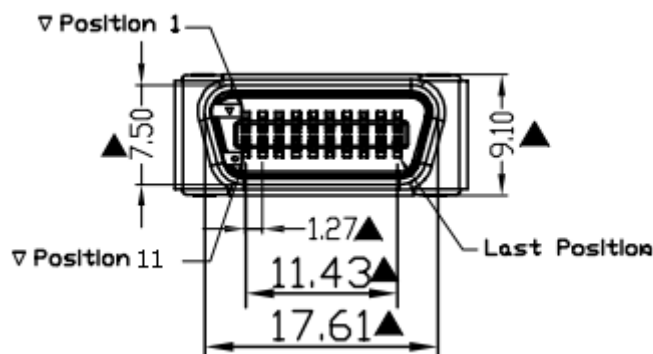

Figure 3-3 I/O pins

Table 3-5 IO function definition

Item	SCSI Pin	Signal	Description	Function
X3 I/O	1	DIN1+	DIN1+ input	High speed digital signal input interface
	2	DIN1-	DIN1- input	

3	DIN2+	DIN2+ input	Scope of input voltage: 5~24VDC Effective input signal: >3VDC and >5mA
4	DIN2-	DIN2- input	
5	DIN3+	DIN3+ input	
6	DIN3-	DIN3- input	Invalid input signal: <1.5VDC Maximum input frequency of optocoupler: 1MHz
11	DIN4	DIN4 input	Low speed digital signal input interface Scope of input voltage:12 ~ 24VDC Effective input signal: > 8VDC and >3mA Invalid input signal:<5VDC Max. input frequency of optocoupler:10kHz
12	DIN5	DIN5 input	
13	DIN6	DIN6 input	
14	COMI	The COM input of DIN4, DIN5, DIN6	
7	AIN1+	AIN1+ Differential input	The analog signal input interface The input impedance:180K Max. input frequency:4kHz Max. withstand voltage:24VDC
8	AIN1-	AIN1- Differential input	
10	GND	Common port both for AIN1 and Logic power	
9	5VDC	5VDC Logic power output	The maximum output current: 200mA
20	24VDC	24VDC Logic power input	Be logic power input when the Power supply is without input
15	OUT1	OUT1 Output	Max. output current:100mA Max. withstand voltage:24VDC
17	OUT2	OUT2 Output	
16	COMO	Common output both for OUT1 and OUT2	
19	OUT3+	Output3+	
18	OUT3-	Output-3	

3.4 Communication Connector

3.4.1 CAN

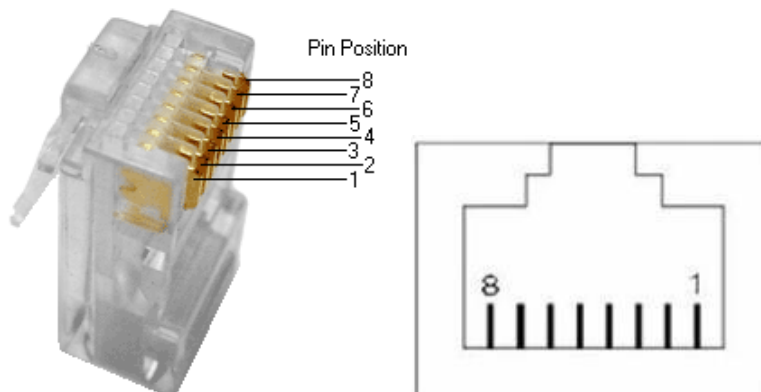

Figure 3-4 pins of RJ45

Table 3-6 Coummunication connector definition

Item	RJ45 Pin	Signal	Description	Function
X1 CAN	1	CAN_H	Differential signal of CAN	CAN Bus connector
	2	CAN_L		
	3	GND	Signal common	
	4	NC	Empty	
	5	NC	Empty	
	6	NC	Empty	
	7	NC	Empty	
	8	GND	Signal common	

3.4.2 RS485

Table 3-7 RS485 Definition

Item	RJ45 Pin	Signal	Description	Function
X1 RS485	1	RX	Received data	RS485B Bus connector
	2	/RX		
	3	GND	Signal common	
	4	/TX	Transmitted data	
	5	TX		
	6	NC	Empty	
	7	NC	Empty	
	8	GND	Signal common	

3.4.3 RS232

Table 3-8 RS232 Definition

Item	RJ45 Pin	Signal	Description	Function
X2 RS232	1	NC	Empty	RS232 Communication connector
	2	NC	Empty	
	3	TX	Transmitted data	
	4	GND	Signal common	
	5	NC	Empty	
	6	RX	Received data	
	7	NC	NC	
	8	NC	NC	

- Notes:**
1. The Stepping Motor Drive of FM860 series, do not support CAN and RS485 at the same time. Defined that the model FM860-AA-000 support CAN and FM860-LA-000 build in RS485 only.
 2. As for X1 connector of FM860, involves X1A (IN) and X1B (OUT). The function of X1A is same to X1B, and convenient the working of parallel connection by RJ45.
 3. RS485 connector has been defaulted as 4-wire Modbus which can use SW7 and SW8 to choose the mode. It will be as 2-wire Modbus If the switch both SW7 an SW8 are ON, otherwise it is 4-wire modbus.
 4. Use SW9 and SW10 to choose 120ohm terminal resistance as ON to merge bus and OFF to disconnect if

Drives are on the end of Bus. Please use SW9 to set up it if the drive with CAN function. As for RS485 connector, there are 2 kind of mode as 2-wire mode using SW9 and 4-wire mode using SW9 and SW10.

3.5 FM860 Connecting View

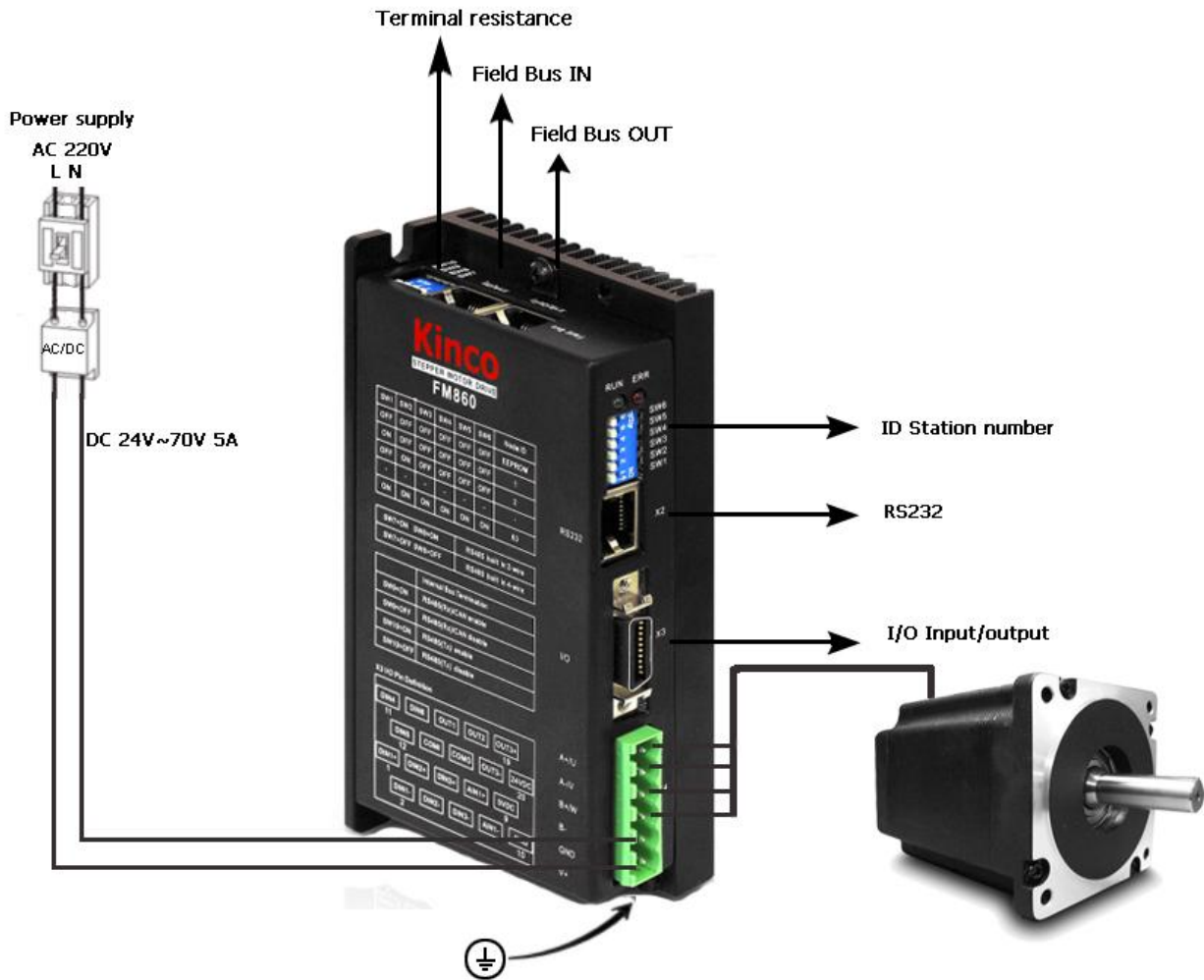

Figure 3-5 FM860 Over view

Chapter 4 Using Kinco Stepping PC Software Installing PC Software

4.1 Installing PC Software

Please access www.kinco.cn to download Kinco Stepping PC Software and unzip to use directly.

4.2 Easy Using

4.2.1 Connecting a PC

You have to use Kinco Stepping PC software to set up the parameter by RS232 or CAN connector.

Please refer chapter 3 to connect Stepping Motor Drive and Motor before using.

How to connect FM860 Stepping motor drive from RS232 to PC? Prepare 24VDC logic voltage, console wire first, and refer the connecting as following.

PC Desub	RS232 (RJ45 connector)
RXD (2) -----	TXD (3)
TXD (3) -----	RXD (6)
GND (5) -----	GND (4)

How to connect the drive from CAN to PC as FM860?

You need to have 24V logic voltage, PEAK series USB or LPT adapter. CAN communication cable, needn't power supply external.

Pecan Desub	CAN (RJ45 connect)
CAN_L (2) -----	CAN_L (2)
CAN_H (7) -----	CAN_H (1)
GND (3) -----	GND (3)

4.2.2 How to use Kinco Stepping PC software

1. Click the Kinco Stepping PC software folder and find the icon as  , and double click it to open the software as following picture.



2. Click File->New.



3. It will popup a dialog as following picture. Please click RS232 if the communication type is serial port, then click the Next.



Click CAN if you use PECAN and press Next key.



4. Then it will show us a dialog as following to set up COM, baud rate, ID and click the Red communication

button .

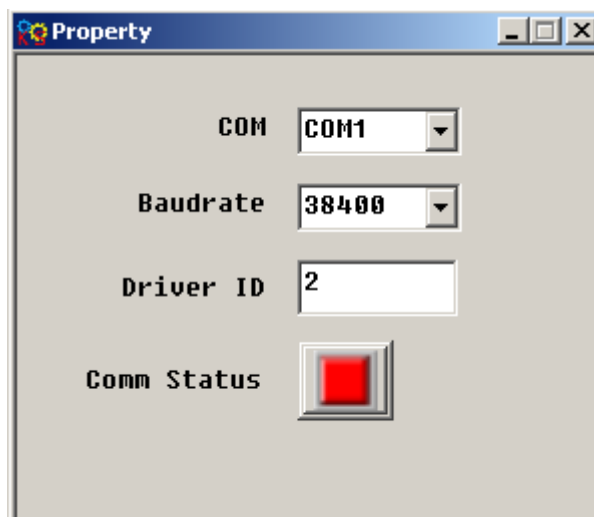

5. Set CAN parameters in following window if you use PECAN. Follows are default parameters.

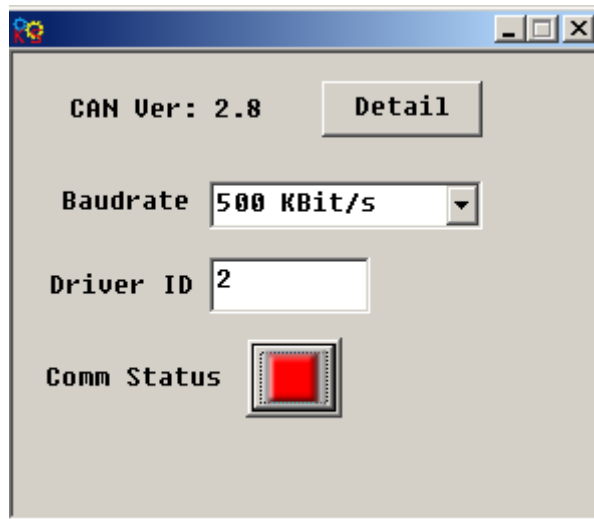

6. Check whether there is Comm Status: Open COM1 38400 on the right-bottom and the light of Comm Status has turned on in green. If yes, it is connecting successful.

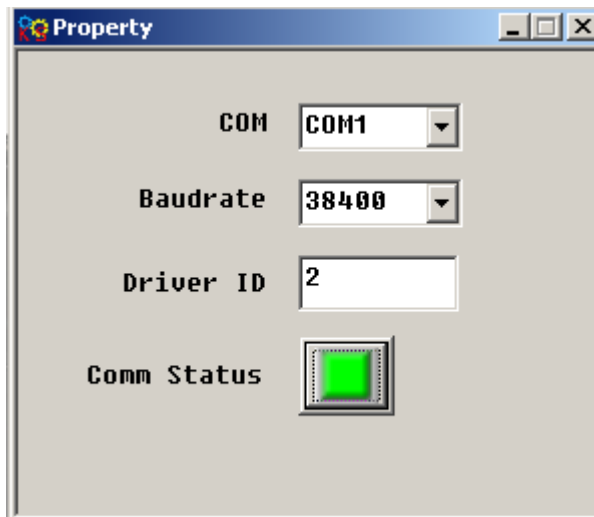

For CAN, it will show us Comm Status: Open 500K Bit/S, and the light is also in green if accessed successful.

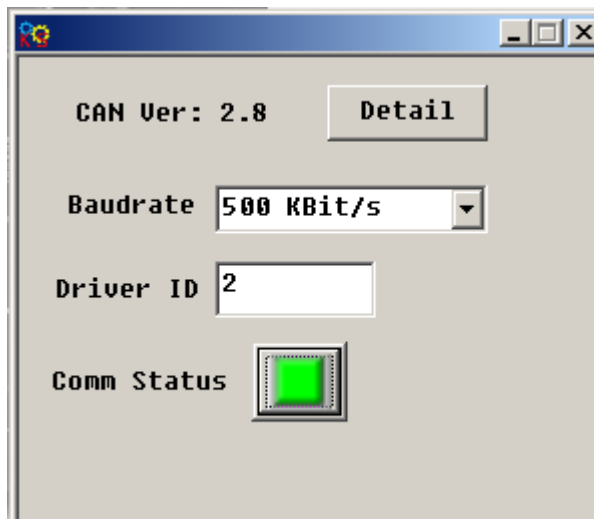

4.3 Operation Your Menu

Click Kinco Stepping PC software, and it will open a window as following:

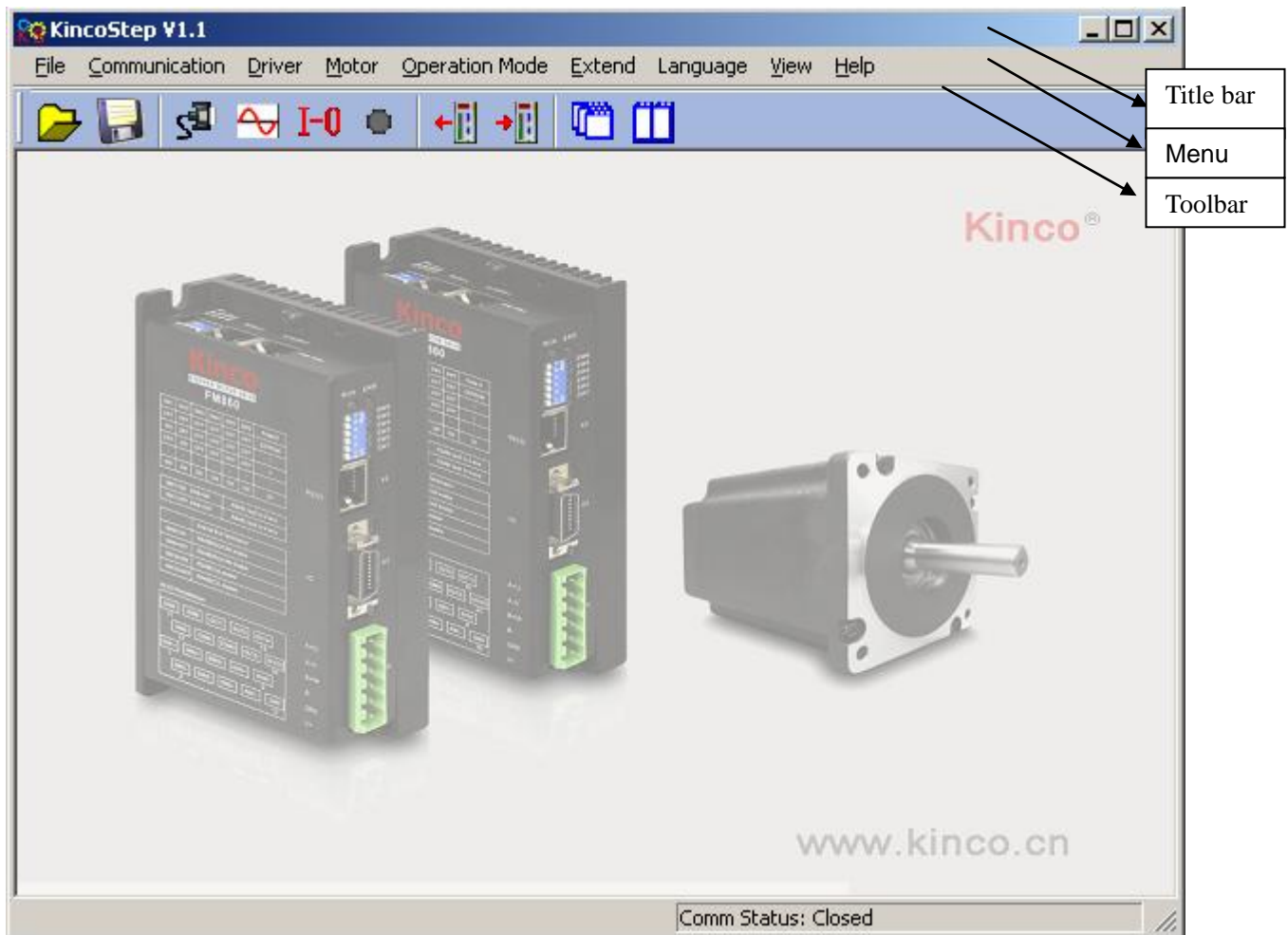

As for such window, you can set up your drive and motor via menu bar. And the details of menu bar are as follows.

Table 4-1 Menu bar introducing

Item	Function description
File	New tasks, Open old file, Save
Communication	Setting up the communication way and parameter from drive to PC.
Drive	Control the Drive, refer to Item 4.4 for details.
Motor	To set up the parameter.
Operation Mode	Homing mode
Extend	Support the language both for English and Chinese, and the function as read, write. Please refer the detail as appendix.

4.4 How to control your Drive

4.4.1 The Drive Settings

	name	data	unit
1	User_Secret	0	DEC
2	Auto_Half_Current_Switch	1	DEC
3	Auto_Current_Percent	50.000	%
4	Half_Current_Time	1.500	S
5	Phase_Current_Limit	4.300	Arms
6	5V_Output_Switch	0	DEC
7	RS232_Bandrate	38400.000	Bandrate
8	RS485_Bandrate	19200.000	Bandrate
9	ID_Com	1	DEC
10	Node_ID_Offset	127	DEC

The dialog can be set for your Drive as for the User-secret. And you also can right click to get help.



4.4.2 Motor configuration

If you prefer to select Software to create motor parameters, please download KincoStep software from www.kinco.cn first, and use console wire(with the connector from RS232 to RJ45) to connect your software and run it.

	name	data	unit
1*	Motor_Using	MC	ASCII
2	Motor_Num	MC	ASCII
3	Motor_Phase	2	phase
4	Motor_Poles	50	2p/r
5	Motor_Phase_Current	1.697	Ap
6	R_Motor	3.200	Ohm
7	L_Motor	6.000	mH
8	Tq_Motor	0.320	Nm
9	Jr_Motor	0.080	kgcm ²
10	Motor_Rotation Dir	0	DEC
11	Feedback_Resolution	60000	DEC/rev
12	Motor_test_switch	1	DEC

There are 3 kinds of methods for user to set up motor parameters.

1. Automatic detection of motor parameters

Follows are the default value for the motor parameters:

Motor type : MC

Motor phase: 2

Motor phase current: 3A (Arms)

Motor_test_switch: 1

Driver setting is defaulted as 2 phase, the LED will show error if you use 3 phase motor actually. So, please change the phase according to the actual phase of motor.

2. Select motor type

User also can select the right motor type if you don't like to use automatic detection of motor parameters, then the parameters will be listed into the dialog by automation. As for the motor type, you can select motor type first, then right click to find the help and click it, then you will see the motor type list.

3) User defined(Motor type as XX)

If you selected the motor which are not in the list, please set motor type as XX, then set the motor parameters by manual.

4.4.3 Current settings

As for factory settings of Motor phase current, defaulted as 3A (Arms)/4.2A(peak). General, the scope of the current is from 0A (Arms) /0A (Peak) ~4.3(Arms)/6A(Peak), which can change by user. It needs to save motor parameters and reboot driver after you modified the value.

Please contact Manufacturer if you need the driver which current is over default value.

4.4.4 Microstep settings

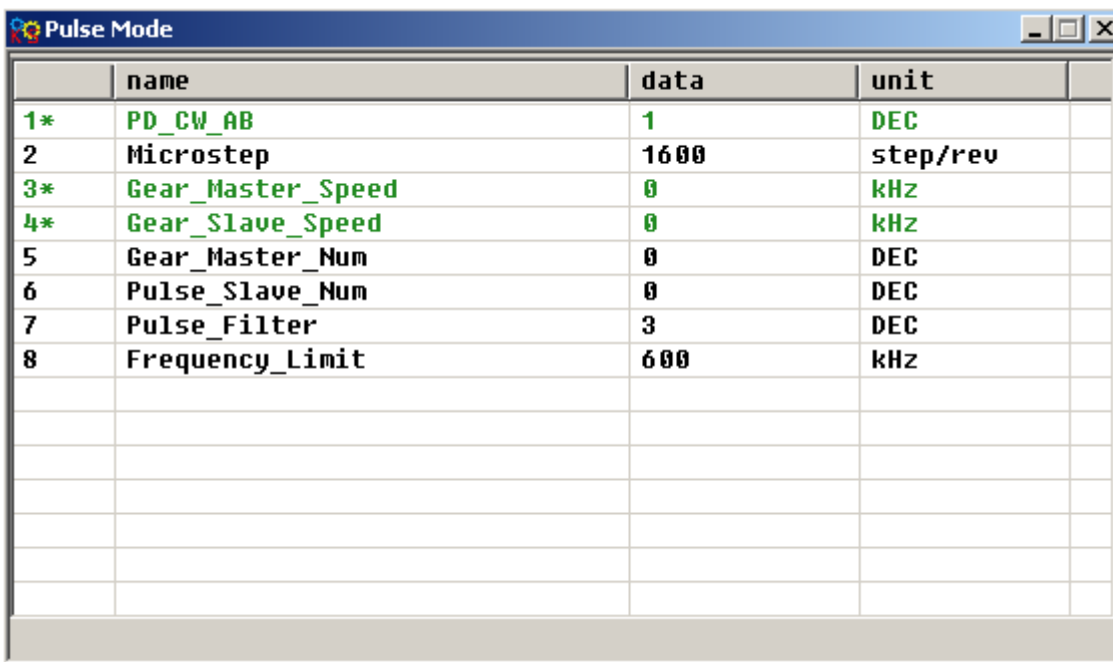

	name	data	unit
1*	PD_CW_AB	1	DEC
2	Microstep	1600	step/rev
3*	Gear_Master_Speed	0	KHz
4*	Gear_Slave_Speed	0	KHz
5	Gear_Master_Num	0	DEC
6	Pulse_Slave_Num	0	DEC
7	Pulse_Filter	3	DEC
8	Frequency_Limit	600	KHz

The setting of microstep in pulse mode (-4 mode), The microstep settings : Microstep equal to the number of pulses per revolution/ (360 % Step angle)

Note: The number of pulses per revolution must larger than or equal to 200 for 2 phase motor setting. As for 3phase motor, the number of pulses per revolution must larger than or equal to 300.

Example 4-1: How to create your password via Kincostep PC software

1. In the window of Drive Configuration, write the password as 1234 (the password range is from 1 to 65535)
2. Click Save control parameters in the Initialize/save of Drive on the toolbar. And need to click save motor parameters if the motor has changed also, then click Reboot drive to save your change.
3. The password is effective after Reboot drive. So you can't do anything for the drive, have to return to Drive Configuration dialog and write the password first.
4. If you want to cancel the password, need to write the old first then change it to 0 and click Reboot drive.

Note: Please set up the motor parameters at the first time, otherwise it can't be running normally, due to the default value with motors.

4.4.5 Basic Setting

It can know the basic information as following window. So we can do some basic setting for drive. As for related mode operation, please refer to chapter 6.

By the way, the window also can monitor the running status of the drive.

	name	data	unit
1*	Operation_Mode_Display	-4	DEC
2*	Status_Word	437	HEX
3*	Position_Actual internal	0.000	step
4*	Real_Speed_RPM	0	rpm
5*	Current_Actual	1.483	Arms
6*	Real_DCBUS_Voltage	24	V
7	Operation_Mode	-4	DEC
8	Target_Position	0.000	step
9	Target_Velocity	0.000	rpm
10	Control_Word	2F	HEX
11	Target_Current	2.979	Arms
12	Profile_Speed	0.000	rpm
13	Profile_Acceleration	10.000	rps/s
14	Profile_Deceleration	10.000	rps/s

Example 4-2: How to operate the Speed-Demand via Kinco PC software

1. Follow example 4-3 and open I/O port. Set DIN1 as Drive enable, DIN2 as Fault reset, DIN3 as Operation mode.
2. Refer to chapter 6.2 profile velocity mode to set up the parameters as the window shown us the speed is 100RPM. And change the value of speed as negative if you want to run it reverse.

4.4.6 I/O Port Settings

As following window, defaulted by system, it allow to change the I/O function, polarity. More details please refer to example 4-3.

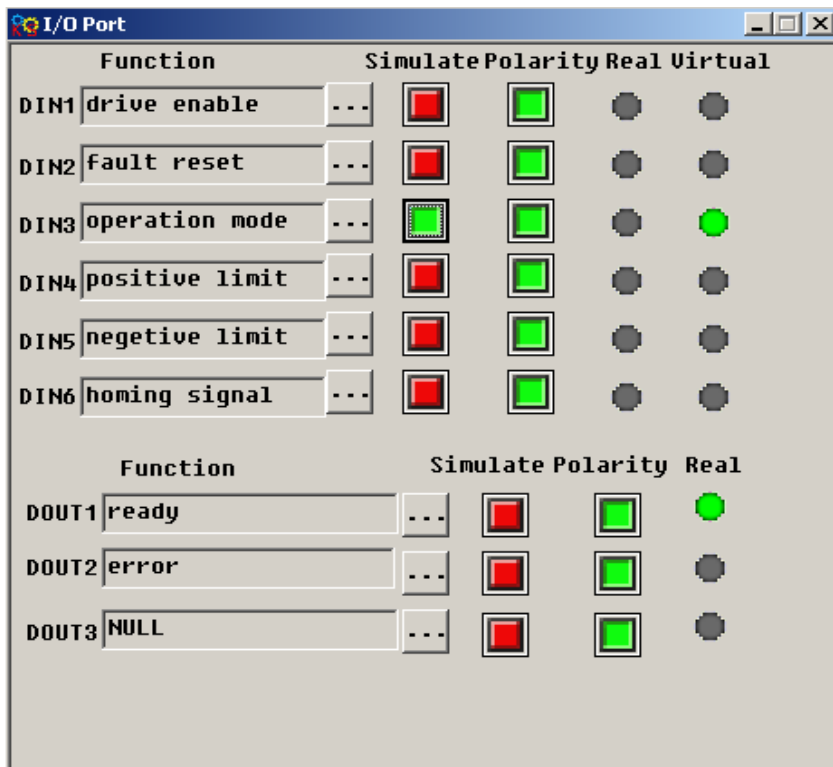

Example 4-3 How to configure I/O via Kinco PC software

Set DIN1 as Drive enable, DIN2 as fault reset, DIN3 as operation mode, DIN4 as positive limit, DIN5 as negative limit, DIN6 as star homing.

1. As following picture, click button  to show us a list and select the item we want and click OK to finish it.

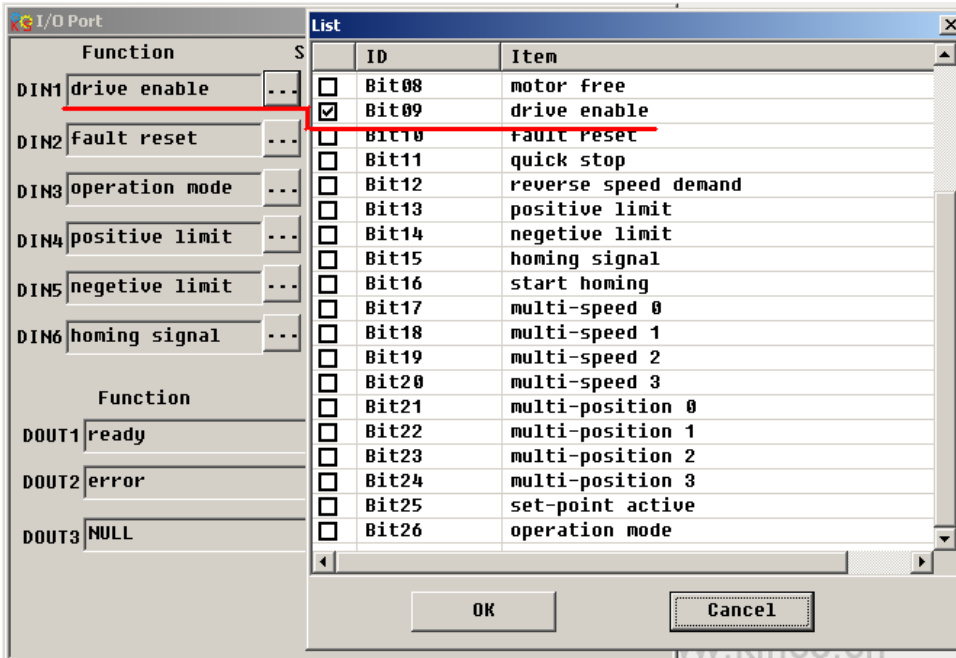

2. Follow step1 to operate the I/O port and finish as below.

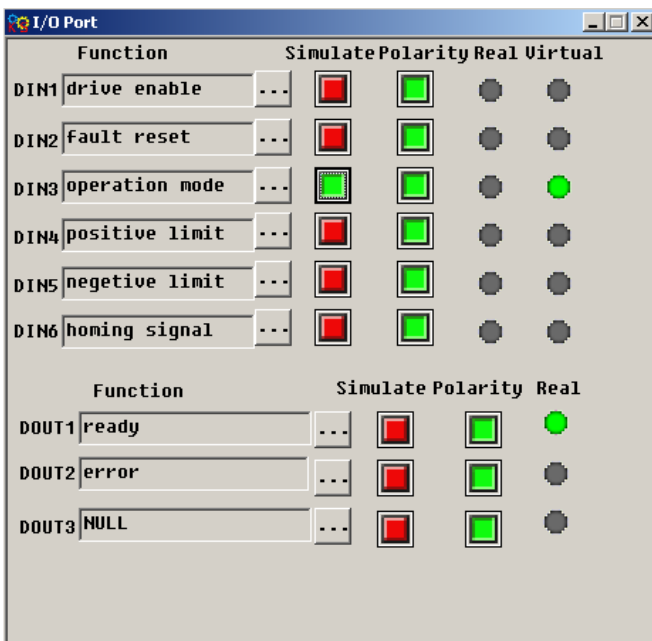

4.4.7 Data dictionary

You can get the index and detail information of all FM Series in the data dictionary. As shown in following picture, left side includes information of index, sub-index and naming of CANopen. Right side is the details of the parameters.

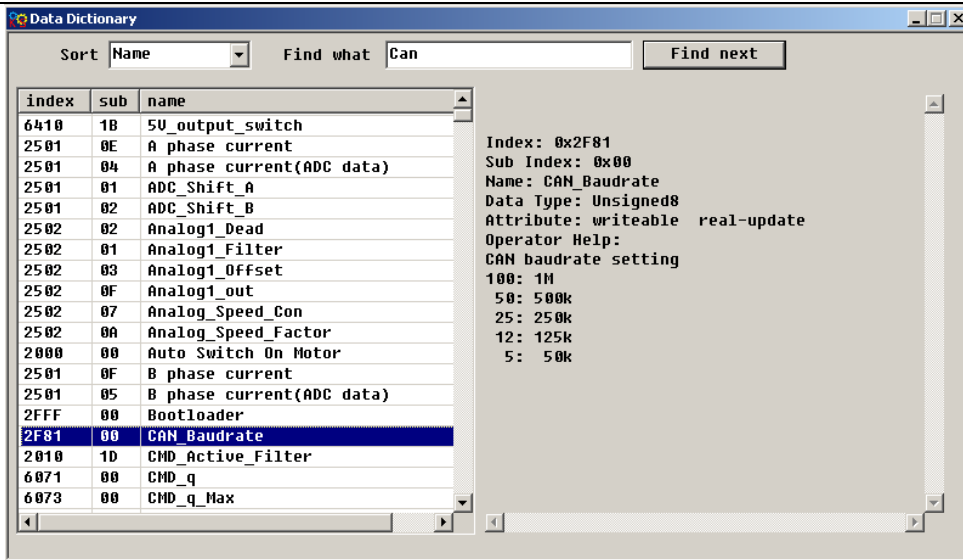

Example 4-4 How to add a index and setting it

Let's learn how to add an index into Basic operation list and setting it. Now we add CANopen Baud rate.

1. Right click in the Basic operation list and choose Add, then it will popup a window of Data Dictionary such as the picture.

2. Input CAN and click Find next, it will jump to 2F81, and to know more information on the right side.

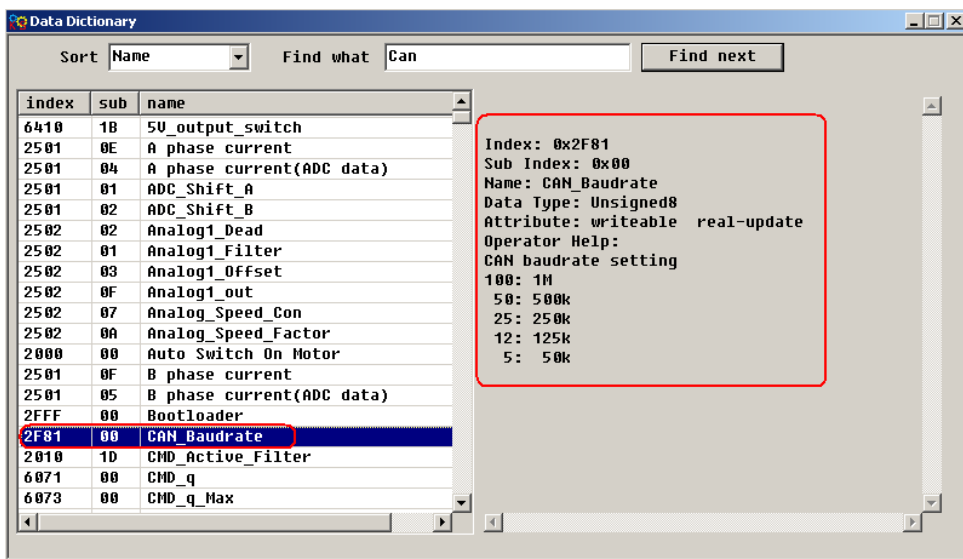

3. Double click the index 2F81, the index will be added into the menu list successful as below.

	name	data	unit
1*	Operation_Mode_Buff	0	DEC
2*	Status_Word	31	HEX
3*	Pos_Actual	0.000	step
4*	Real_Speed_RPM	0	rpm
5*	I_q	0.000	Ap
6	Operation_Mode	1	DEC
7	Pos_Target	0.000	step
8	Speed_Demand	0.000	rpm
9	Control_Word	6	HEX
10	CMD_q_Max	1.991	Ap
11	Profile_Speed	0.000	rpm
12	Profile_Acce	10.000	rps/s
13	CAN_Baudrate	50	DEC
14	Profile_Dece	10.000	rps/s
15	Din1_Function	100	HEX

4. How to cancel the index in the menu list? Find it and click your PC on the right then click del to finish it. If want to know more information about a index, find it and click your PC mouse then click help.

4.4.8 ECAN Setting

As for this menu list, it can set the communication parameters of CANopen. please refer to chapter 7.3.

	name	data	unit
0	Group_RX1_PDO	0	DEC
1	RX1_PD01	0	HEX
2	RX1_PD02	0	HEX
3	RX1_PD03	0	HEX
4	RX1_PD04	0	HEX
5	RX1_PD05	0	HEX
6	RX1_PD06	0	HEX
7	RX1_PD07	0	HEX
8	RX1_PD08	0	HEX
9	RX1_ID	201	HEX
10	RX1_Transmission	254	DEC
11	RX1_Inhibit_Time	0	ms

	name	data	unit
0	Group_TX1_PDO	0	DEC
1	TX1_PD01	0	HEX
2	TX1_PD02	0	HEX
3	TX1_PD03	0	HEX
4	TX1_PD04	0	HEX
5	TX1_PD05	0	HEX
6	TX1_PD06	0	HEX
7	TX1_PD07	0	HEX
8	TX1_PD08	0	HEX
9	TX1_ID	181	HEX
10	TX1_Transmission	254	DEC
11	TX1_Inhibit_Time	0	ms

	name	data	unit
0*	Vendor_ID	300	HEX
1	Sync_ID	80	HEX
2	Guard_Time	1000	ms
3	Life_Time_Factor	3	DEC
4	Node_Guarding_ID	702	HEX
5	Emergency_Mess_ID	81	HEX
6	Producer_Heartbeat_Time	0	ms
7	CAN_Baudrate	50	DEC

4.4.9 Drive Property

We can know the information of drive such as software version, S/N and so on in the window.

	name	data	unit
1*	Device_Type	40192	HEX
2*	Device_Name	FM860-AA driver	String
3*	Product_Version	V0.1	String
4*	Software_Version	FM086020130906	String
5*	Manufacturer	Kinco Electric (Shenzhen) Ltd.	String
6*	Serial_Num	FM0860101013048001	String
7*	Vendor_ID	300	HEX
8*	System_Time	22858	S
9*	Temperature	36	degree

4.4.10 Error Control

This menu will show the error status if there is any error. In the menu, the code of 16 hex is the error code, and the box is used to select whether the alarm is shielded or not. The light will turn red if there is error,

more details please refer to chapter 8.

Note: Untick the box to shield the error if you need, but some of errors can't shield.

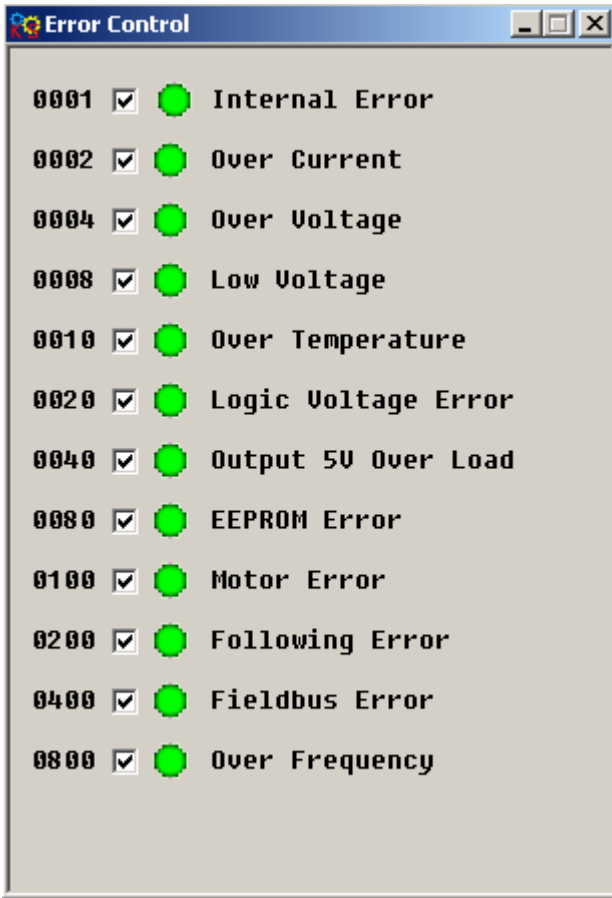

4.4.11 Error History

As for FM860 Stepping motor Drive, there are 7 groups of historical error information.

In following picture, Error-point is the number of the pointer for current error. Error-history [N] means the current error at the [N]. As for last error record, is N -1 (for example, N is 4, the last error record is 4-1=3, the value is 3), the next error record is N+ 1. There are 8 error-history.

The 'Error History' window displays a table with 15 rows of error history data. The columns are 'name', 'data', and 'unit'. The data is as follows:

	name	data	unit
1*	Error_Count	13	DEC
2*	Error_Point	4	DEC
3*	Error_History[0].error_state	101	HEX
4*	Error_History[0].error_bits	8000	HEX
5*	Error_History[0].DCBUS	21	V
6*	Error_History[0].Speed	0.000	rpm
7*	Error_History[0].Current	0.000	Ap
8*	Error_History[0].Mode	0	DEC
9*	Error_History[0].time_month	0	Mon
10*	Error_History[0].time_min	300	Min
11*	Error_History[0].Temperature	23	degree
12*	Error_History[1].error_state	101	HEX
13*	Error_History[1].error_bits	8000	HEX
14*	Error_History[1].DCBUS	21	V
15*	Error_History[1].Speed	0.000	rpm

4.4.12 Initialize/Save

The menu provides save parameters, initialize control parameters and reboot drive. Pay attention to that motor parameters is saved separately.

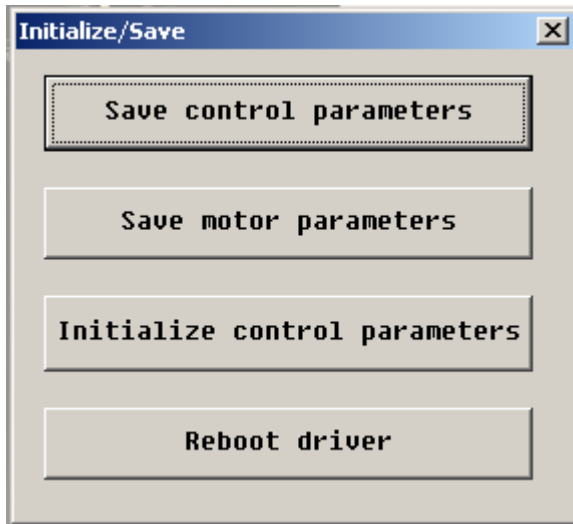

Chapter 5 Operating the I/O Port

As for FM860, there are 6 channels digital input, 3 channels digital output.

Both for digital input and output setting is flexible. You can set up the function of I/O as the real requirement.

5.1 Digital signal input

5.1.1 The Polarity control of digital input

Now, make S1 as open or close to change the polarity of IO via Kincostep PC software. It means the polarity is open if the light is in green, the DIN1 is un-working.

Example 5-1, How to set up the digital signal input as DIN1

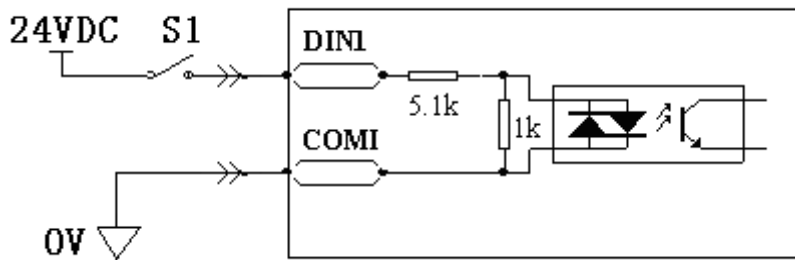

Figure 5-1 Polarity settings of digital signal input as DIN1

1. Kincostep PC software has running in FM860 successful.
2. Open I/O window. And click DIN4 and DIN5 polarity light which will become in red, now DIN4 and DIN5 is close, then DIN1 is effective.

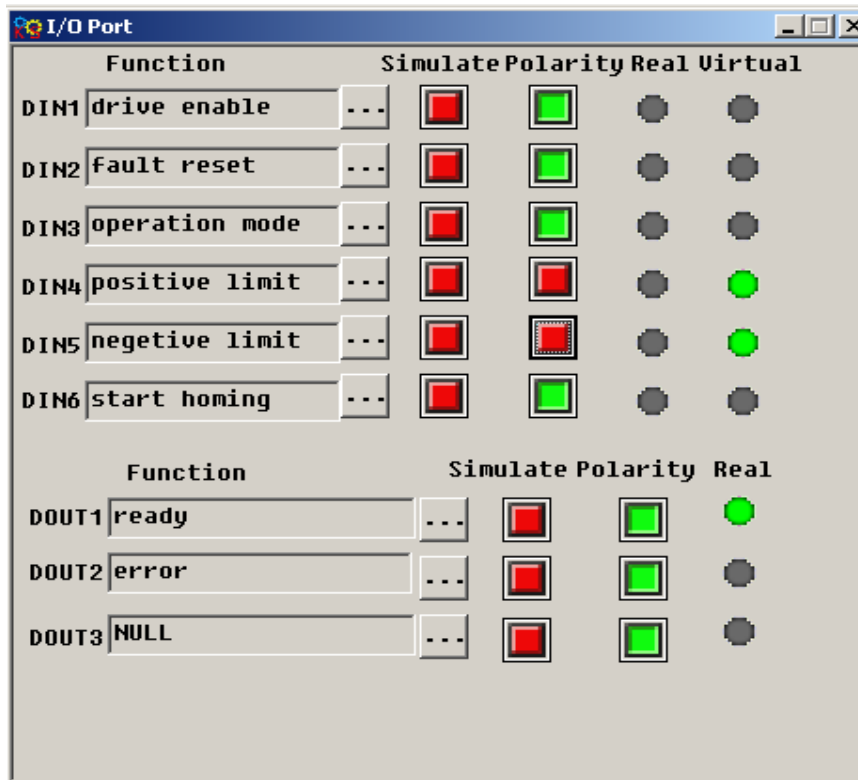

Figure 5-2 Digital I/O View of PC Software

5.1.2 Digital signal input address and function

Table 5-1 Digital signal input function and default value

NAME	FUNTION	Value
DIN1_Function	Pulse input Direction input Clockwise pulse input	01 (Pulse)
DIN2_Function	Counterclockwise pulse input Quadrature encoder phase A input Quadrature encode phase B input	02 (Direction input)
DIN3_Function	Quadrature encoder index input Motor free Drive enable	03 (motor free)
DIN4_Function	Fault reset Quick stop Reverse speed demand	04(NULL)
DIN5_Function	Positive limit Negative limit Homing signal	05(NULL)
DIN6_Function	Start homing Multi-speed 0 Multi-speed 1 Multi-speed 2 Multi-speed 3 Multi-position 0 Multi-position 1 Multi-position 2 Multi-position 3 Set-point active Operation mode	06(NULL)

Table 5-2 Meaning of digital signal input

Function	Meaning	
Pulse input	In the mode as pulse plus direction, the pulse signal input	Note: Only DIN1 and DIN2 can support these functions.
Direction input	In the mode as pulse plus direction, the direction signal input	
Clockwise pluse input	In double-pulse mode, the CW pulse input as clockwise	
Counterclockwise pulse input	In double-pulse mode, the CW pulse input as counterclockwise	
Quadrature encoder phase A input	Incremental encoder mode, A phase signal input	

Quadrature encode phase B input	Incremental encoder mode, B phase signal input	
Quadrature encoder index input	Incremental encoder mode, Z phase signal input	
Motor free	Motor off, and motor axis is loose in avail status	
Drive enable	Drive enable, control word in avail status can be configured via object 202033 to input control word	
Fault reset	Clear error alarm, the rising edge of the signal is detected	
Quick stop	When the signal is valid, the motor shaft releases. After the signal is removed, the drive requires re-enabling.	
Reverse speed demand	To reverse the target speed in the speed mode.	
Positive limit	Indicates the limit of forward running of motors (normally closed by default. the drive regards position positive limits as valid, and polarity can be modified to adjust to normally open switches.	
Negative limit	Indicates the limit of inverted running of motors (normally closed contact by default. the drive regards position negative limits as valid, and polarity can be modified to adjust to normally open switches.)	
Homing signal	Homing switch signal	
Start homing	Star the command of homing, the rising edge of the signal is detected.	
Multi-speed 0	Using it to control the switch of multi-position. Input signal 3-0 to consist a number in hex.	
Multi-speed 1		
Multi-speed 2		
Multi-speed 3		
Multi-position 0	Used to switch Multi-position. Input signal as 4bits from 3-0 to consist a number in hex.	
Multi-position 1		
Multi-position 2		
Multi-position 3		
Set-point active	Create target-position or position segment, the ring edge of the signal is avail.	
Operation mode	To switch 2 kind of mode. The mode of valid signal and invalid can be defined as flexible. Need to via object 202031 input operation mode and select 0 and the object 202032 to select 1 to configure.	

Example 5-2 How to set up drive enable by PC software

As following picture, click button  to show us a list and find the item we want and click OK to finish it.

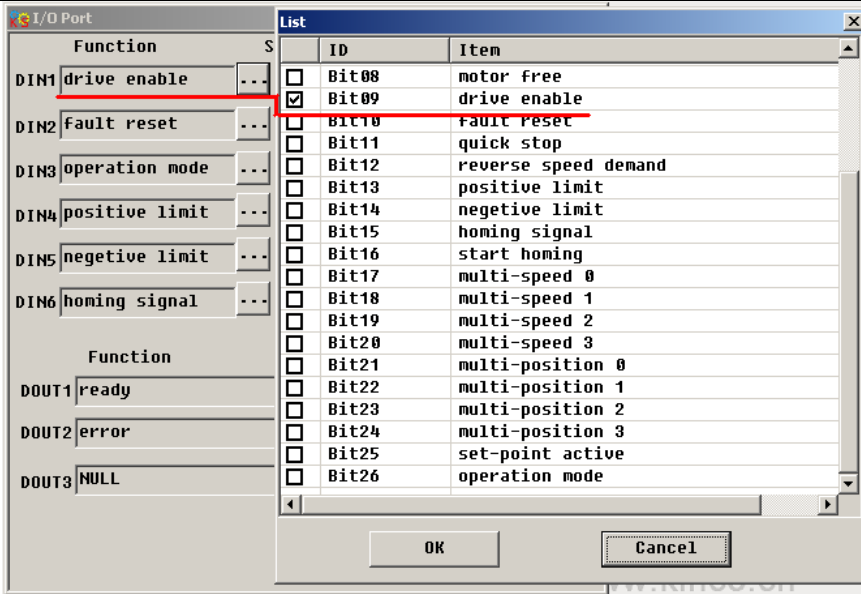

Figure 5-3 I/O function setting

Example 5-3 How to set up pulse input

As for the pulse input function, it is supported both for DIN1 and DIN2 support only. If DIN1 is pulse input, DIN2 will be as direction input if DIN1 have the signal as pulse input, and DIN2 can not be as NULL. Otherwise it will not work.

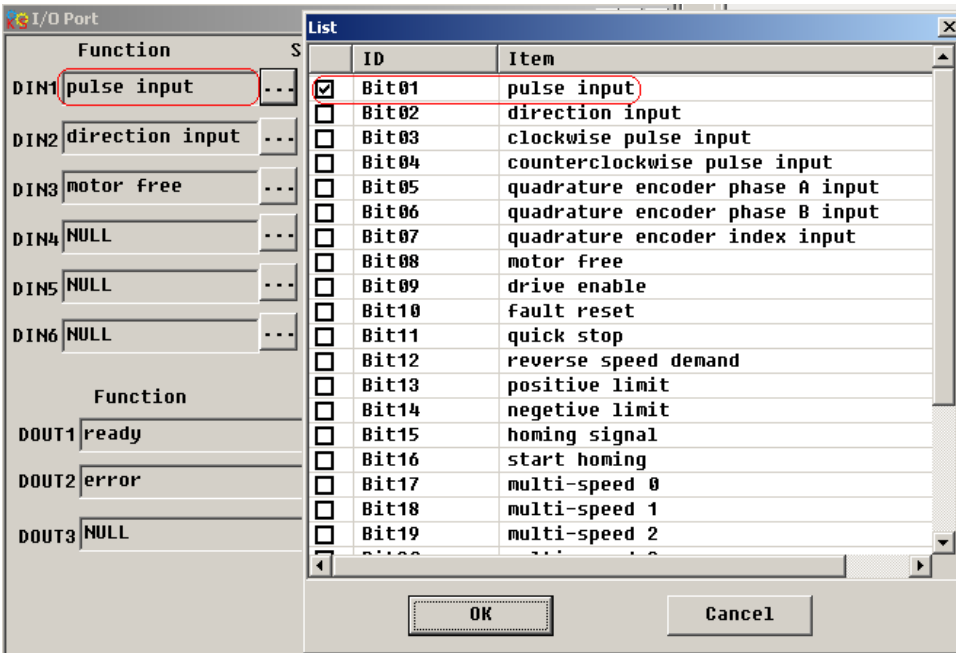

Figure 5-4 I/O function setting

5.1.3 Digital input both for NPN and PNP

1.NPN Wiring Diagram (Support the effective controller of low level output)

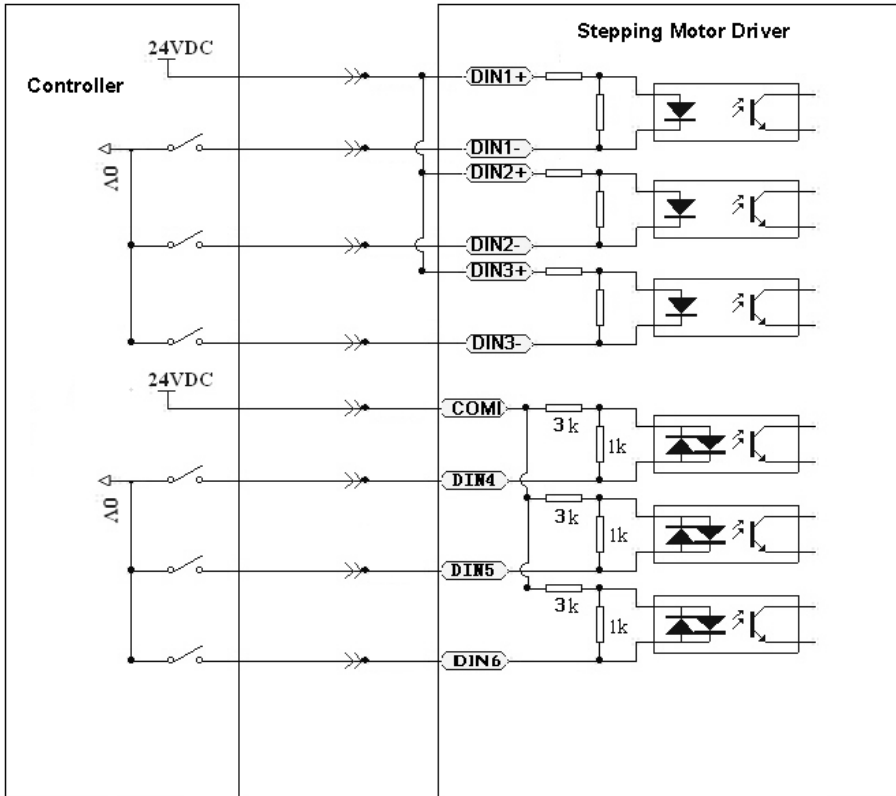

Figure 5-5 NPN Wiring

2. PNP Wiring Diagram (Support the effective controller of high level output)

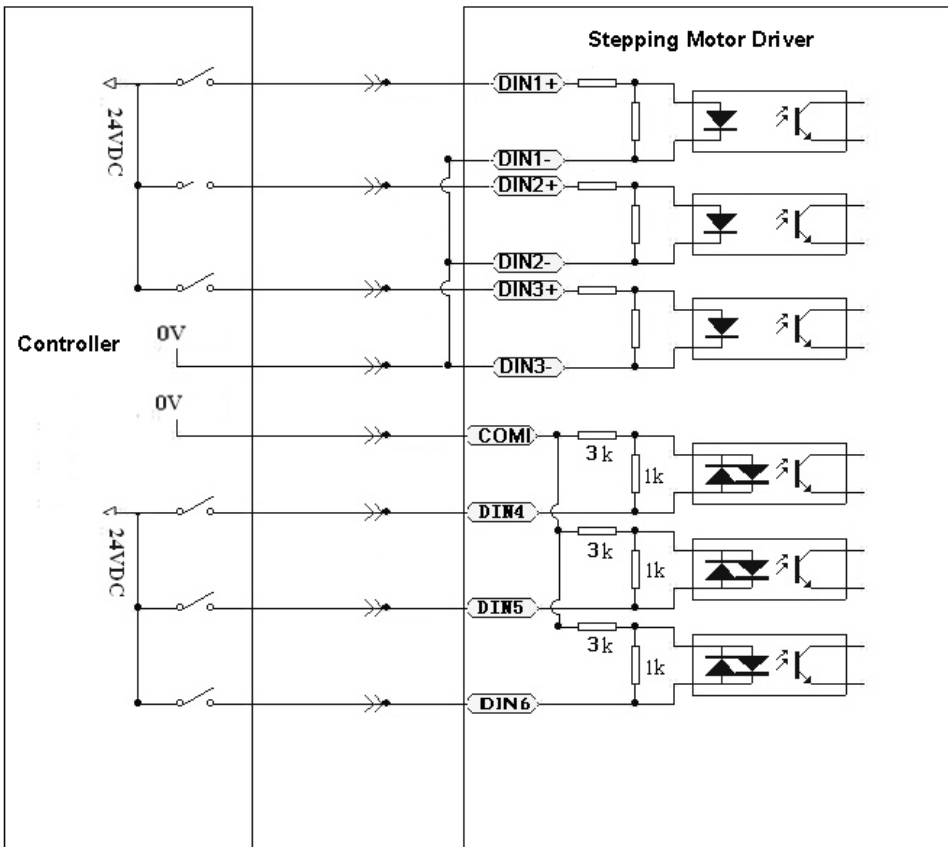

Figure 5-6 PNP Wiring

5.2 Digital signal output

5.2.1 The Polarity control of Digital signal output

The polarity of digital output is defaulted as open. About how to change the polarity please refer to example 5-1.

5.2.2 Digital signal output address and function

Table 5-3 Digital signal output and default function

Name	Function	Value
DOUT1_Function	Ready	01 (read)
	Error	
DOUT2_Function	Position reached	02 (error)
	Zero velocity	
	Motor brake	
DOUT3_Function	Velocity reached	03 (NULL)
	Index signal	
	Max velocity limit	
	PWM ON	
	Position limiting	
	Reference found	
	Index signal frequency	
	Absorb voltage	

Table 5-4 Meaning of Digital output signal function

Function	Meaning
Ready	Drive is on operation mode
Error	Alarm status
Position reached	In position mode, target-position data is no change from position to time window. And while the position error in the position to the window.
Zero velocity	Motor velocity is zero after motor enable
Reserved	Function is pending
Velocity reached	Motor speed reached the target in the control of speed mode
Reserved	Function is pending
Reserved	Function is pending
PWM ON	Drive enable motor
Position limiting	Motor is in limit
Reference found	End of homing
Index signal frequency	Index signal seems to be homing, and set output periodic pulse.
Absorb voltage	To absorb the main voltage, used as 3 phase driver and connecting resistor between V+ and B-

Example 5-5 How to set Driver ready

1. Connect Kincostep PC software to FM860.

2. Open I/O window. And click the button as  in DIN1, and find ready and mark it in the list as following

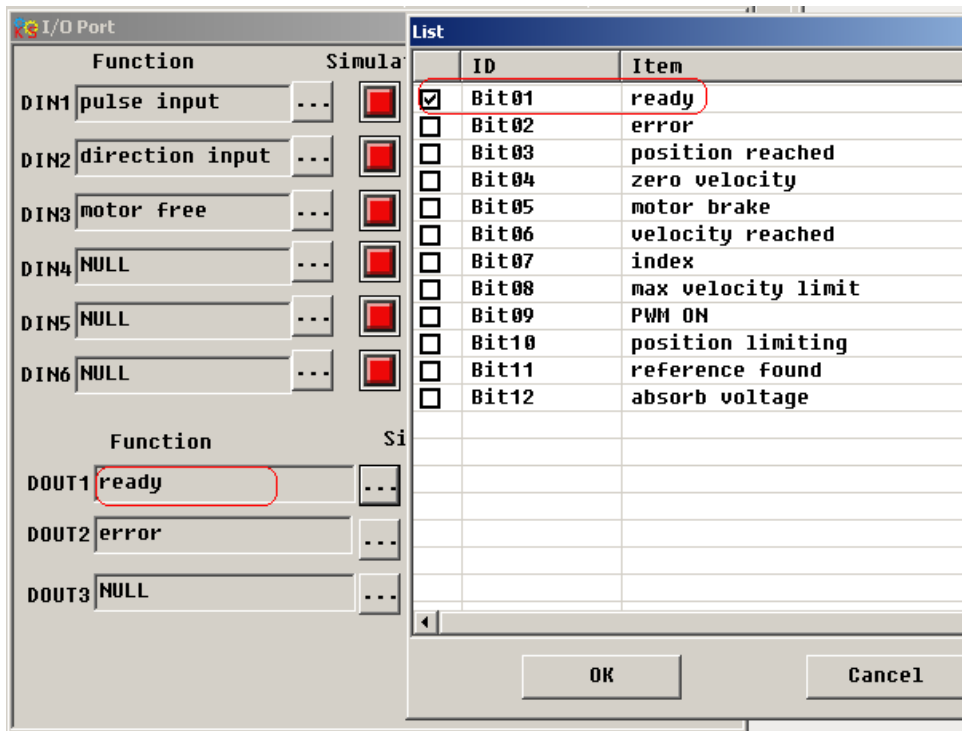

Figure 5-7 Drive standby

5.2.3 Digital output

1 Digital output wiring diagram

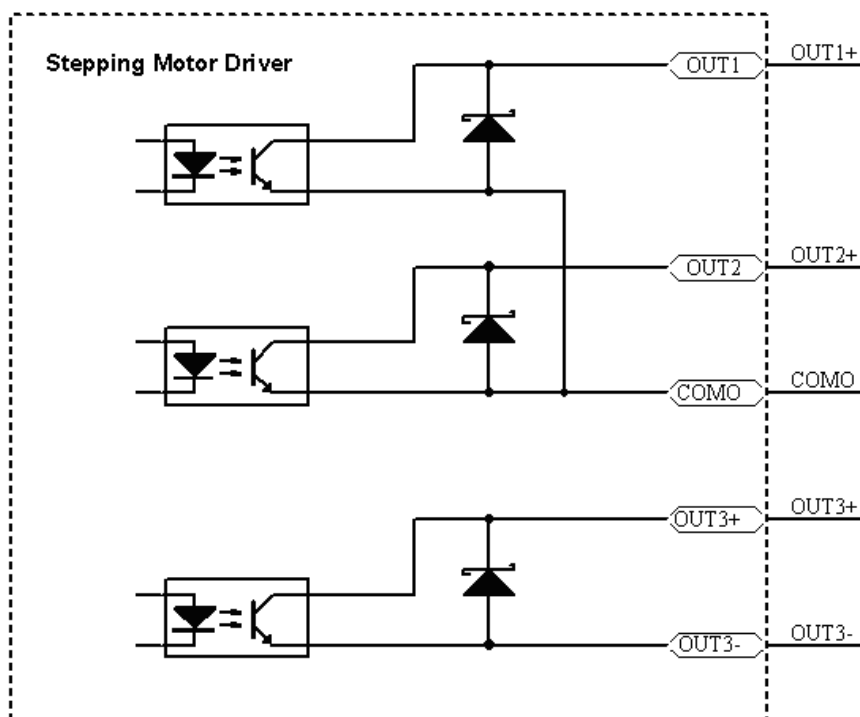

Figure 5-8 internal diagram of digital output

2.NPN wiring diagram (OUT1-OUT3 support NPN and the effective controller of low level input)

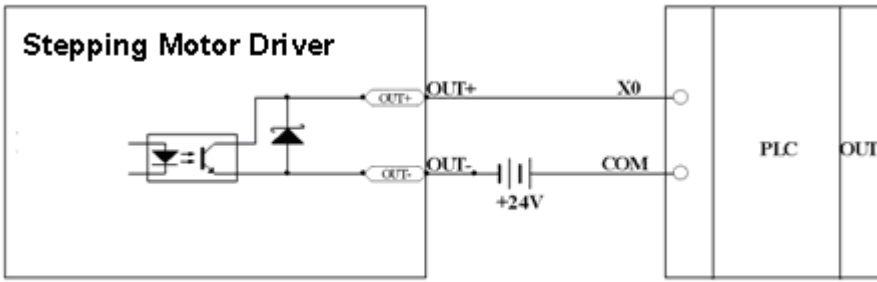

Figure 5-9 NPN Wiring(Common cathode)

3.PNP wiring diagram (only OUT3 support PNP and the effective controller of high level input)

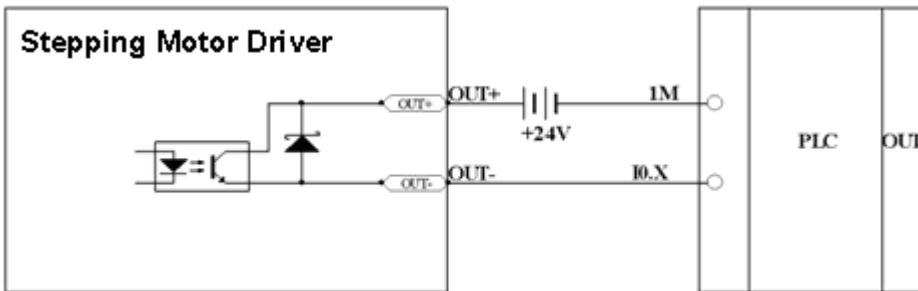

Figure 5-10 PNP Wiring (Support the effective controller of high level input)

4. Follow the diagram as below to connect relay to the digital output.

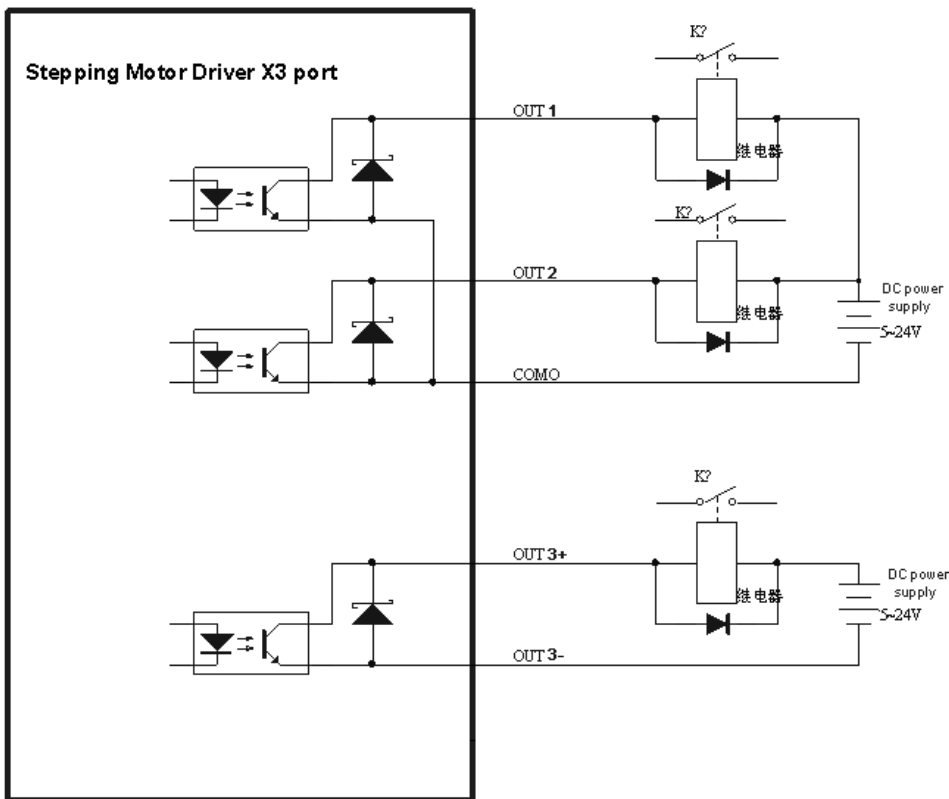

Figure 5-11 Connecting relays on digital output (Anti-parallel diode)

5.3 Analog signal input

5.3.1 AIN1 common mode voltage input

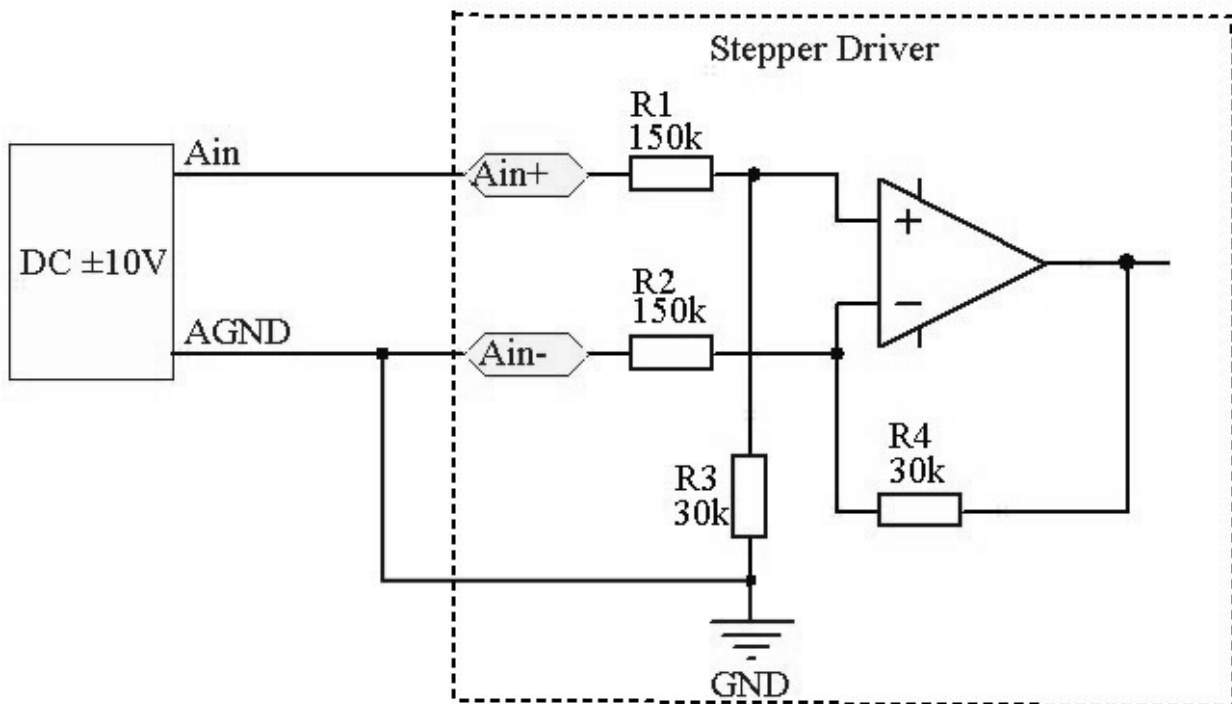

Figure 5-12 Common mode input voltage wiring diagram

5.3.2 AIN1 Differential mode voltage input

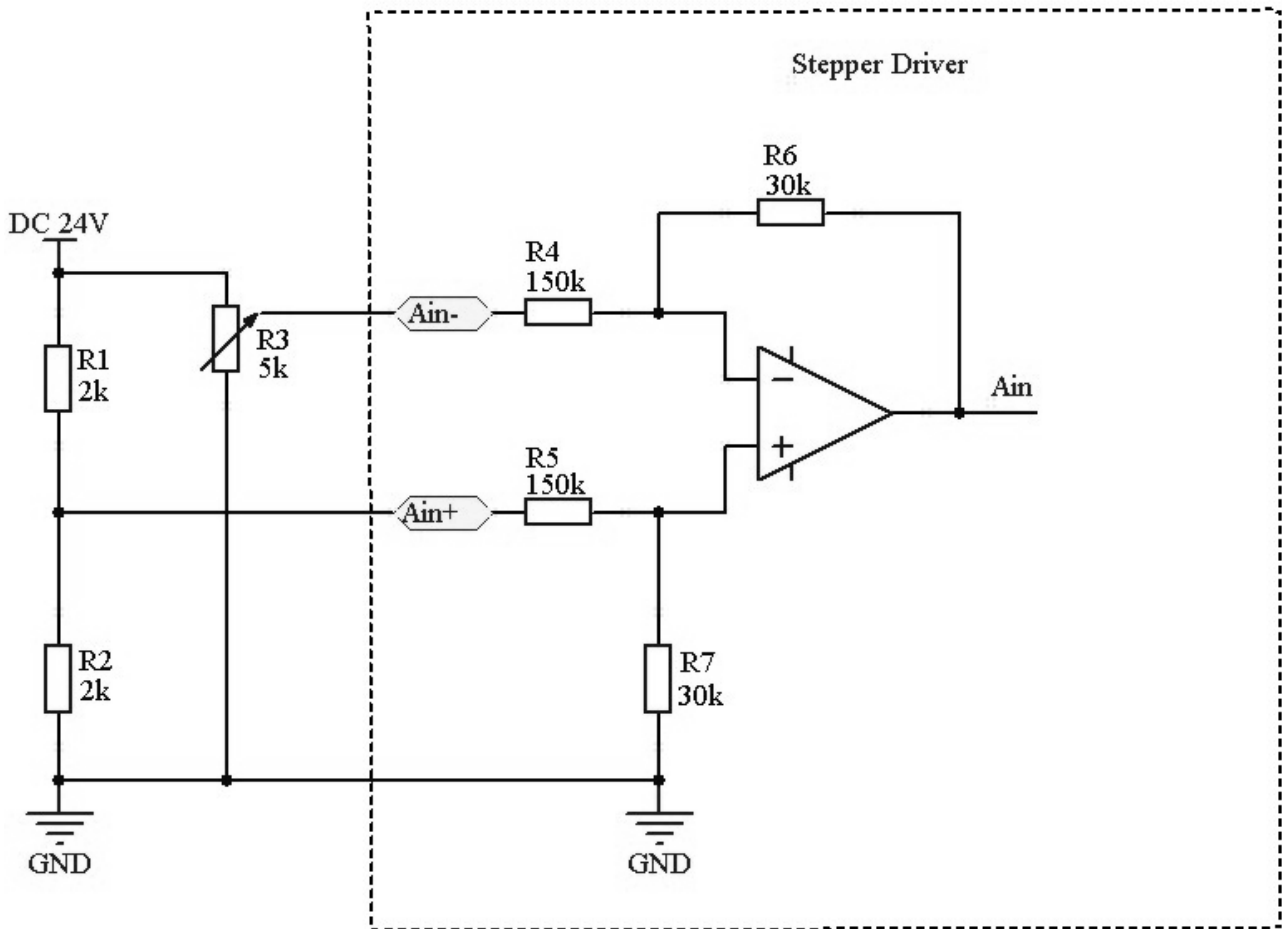

Figure 5-13 Differential mode input voltage wiring diagram

Chapter 6 Operating Mode

6.1 Profile position mode 1

Now make an example to explain this mode. Coordinate system as shown below, the red arrow is defined as the current position 450, if we make the absolute position movement, when the target position is set to 700, the motor will run to coordinate position of 700 ; if we make a relative position movement, when the target position is set to 700, the motor will run to the coordinate position of 1150.(Now make a example to explain this mode. The Coordinate system, as to the red arrow is defined as the current position is 450, if we make the absolute position movement, when the target position is set to 700, the motor will run to Coordinate the position of 700; If we make a relative position movement, when the target position is set to 700, the motor will run to the coordinate position of 1150.)

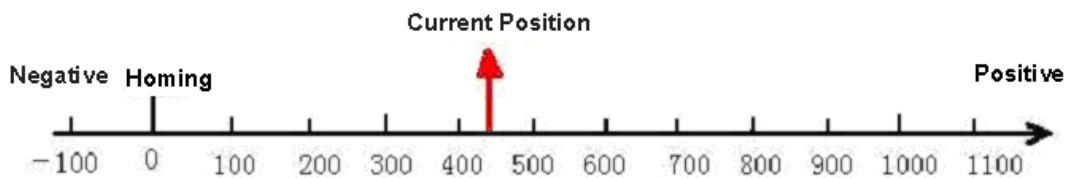

Figure 6-1 Absolute/ Relative position

Table 6-1 Objects in Mode 1

Name	CANopen address	Modbus address	Value	Meaning
Operation_Mode	60600008	0x3500	1	To set up operation mode as absolute position mode and relative position.
Profile_Speed	60810020	0x4A00	User Setting	speed of trapezoidal curve
Profile_Acce	60830020	0x4B00	User Setting	Profile_Acce
Profile_Dece	60840020	0x4C00	User Setting	Profile_Dece
Pos_Target	607A0020	0x4000	User Setting	target position
Control Word	60400010	0x3100	Write 2F first then 3F	Absolute position is running then Motor Begin run.
			Write 4F first then 5F	Relative position is running then Motor begin run.
			103F	According to the change of target position, begin absolute position moving immediately.

Please refer [Appendix VII](#) for more information. And read chapter 9 if want to know how to set up profile position mode by communication or I/O to finish it.

6.2 Profile velocity mode 3

As for the mode 3, can running for the speed control of Motor. The running curve involves 3 phase as accelerating, uniform speed and speed reduction. The time of accelerating can figure out by initial velocity, Uniform speed and accelerated speed as below.

$$V_t = V_0 + at \quad V_t - \text{Uniform speed}$$

V_0 - Initial velocity

a - Accelerated speed or depend reduction

t - Acceleration time

$$S = V_0t + (1/2) at^2 \quad S - \text{Accelerated segment displacement}$$

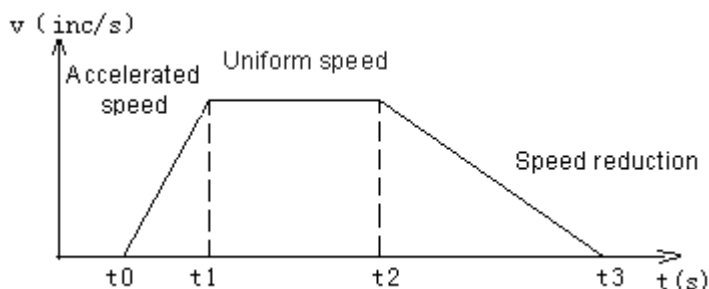

Figure 6-2 The curve both for speed and time of Mode3

Table 6-2 Objects in Mode 3

Name	CANopen address	Modbus address	Value	Meaning
Operation_Mode	60600008	0x3500	3	operation mode of drive
Speed_Demand	60FF0020	0x6F00	User Settings	target speed
Profile_Acce	60830020	0x4B00	User Settings	acceleration of trapezoidal curve acceleration of trapezoidal curve
Profile_Dece	60840020	0x4C00	User Settings	acceleration of trapezoidal curve
Control_Word	60400010	0x3100	write 6 first then F	Lock the motor shaft, write such parameters and run it as the parameter request. And motor will re-run after you write new speed value

Please refer Appendix VII for more information. And read chapter 9 if want to know how to set up profile velocity mode by communication or I/O port to finish it.

6.3 Pulse Control Mode -4

The motor running is monitored by X3 port of Drive in the mode -4. And the index is as below.

Table 6-3 Objects in Mode -4

Name	CANopen address	Modbus address	Value	Meaning
Operation_Mode	60600008	0x3500	-4	Set up operation mode to be pulse control mode
microstep	64101810	0x7180	User Setting	the number of pulses per motor revolution
Control_Word	60400010	0x3100	F	Lock motor, motor begin to move.

Note: Please re-define the IO port both for DIN1 and DIN2 as example of 5-3.

And refer Appendix VII for more information about the index of objects.

6.4 Homing Control Mode 6

It must define the homing before you do the localization of absolute position. As following picture shown that have to define the homing as 0, 0 before locate X and Y=100mm, 200mm.

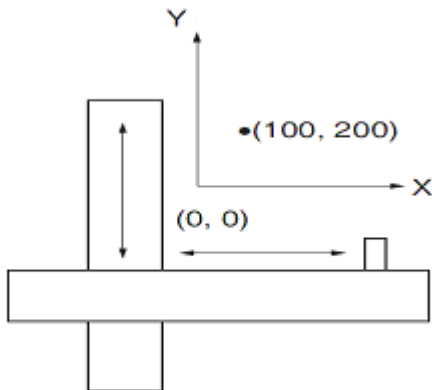

Figure 6-3 Homing control mode

Table 6-4 Objects in mode 6.

NAME	CANopen address	Modbus address	Value	Meaning
Operation_Mode	60600008	0x3500	6	operation mode of drive is homing mode
homing mode	60980008	0x4D00	User Setting	method for searching homing
Home_Offset	607C0020	0x4100	User Setting	offset after homing
Homing_Speed_Switch	60990120	0x5010	User Setting	velocity for searching homing switch signal
Homing_Speed_Zero	60990220	0x5020	User Setting	velocity for searching homing signal
Homing_Accelaration	609A0020	0x5200	User Setting	Homing Accelaration
Control_Word	60400010	0x3100	Write F first the 1F	Lock motor, motor begin to move.

Please refer Chapter 9 to know how to control homing mode.

6.5 How to simulate velocity mode 3

6.5.1 The index of velocity mode 3

The motor running is handled by X3 port of Drive in this mode. And the index is as below.

Table 6-5 Objects in mode 3

NAME	CANopen address	Modbus address	Value	Meaning
Operation_Mode	60600008	0x3500	3	Operation mode of drive is target speed control mode.
Analog 1_Filter	25020110	0x1610	User Setting	filter parameter of analog signal as

				$f=4000/(2\pi * \text{Analog1_Filter})$ time constant: $\tau = \text{Analog1_Filter}/4000$ (S)
Analog 1_Dead	25020210	0x1620	User Setting	dead space of analog signal 1
Analog1_Offset	25020310	0x1630	User Setting	offset of analog signal 1
analog1_out_polarity	25021410	0x1740	User Setting	polarity of analog output 0: The same as the input polarity 1: In contrast to the input polarity
analog_speed_rpm at 10V	25021310	0x1730	User Setting	Analog 10V speed, it is without dead and offset.
Analog_Speed_Con	25020708	0x1670	User Setting	Analog signal control speed, valid at operation mode 3 0x0: not valid 0x1: speed controled by analog signal 1 0x10...0x1f: Ain1 control the "target speed control[x-0x10]"
Profile_Acce	60830020	0x4B00	User Setting	acceleration of trapezoidal curve
Profile_Dece	60840020	0x4C00	User Setting	acceleration of trapezoidal curve
Control_word	60400010	0x3100	F	Lock motor, motor begin to move.

More details please refer Appendix VII.

6.5.2 The Process diagram of analog signal

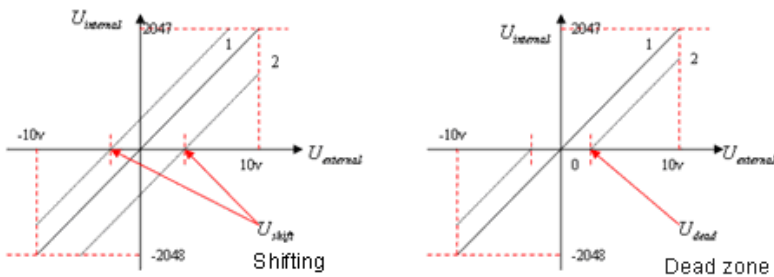

Figure 6-4 Analog signal process

Table 6-6 Variable of analog signal

Variable	Meaning	Scope
$U_{internal}$	External voltage is same to internal	-10V~10V

	data.	Without offset and dead zone voltage, the scope is from -2048 to 2047.
U_{external}	Power supply voltage	-10V~10V
U_{shift}	offset voltage	the scope of 0~10 is 0~8191
U_{dead}	Dead zone voltage	The scope of 0~1 is 0~8191

6.5.3 How to simulate velocity mode 3 without dead zone voltage and offset

Requirement: Choose DIN1 as drive enable, DIN2 as fault, 无限位开关。And 10V is at rated 1000rpm, -10V is at rated -1000rpm. As for the speed, controlled by analog signal 1 as AIN1.

Table 6-7 Parameter settings

NAME	CANopen address	Modbus address	Value	Meaning
Operation_Mode	60600008	0x3500	3	Operation mode of drive is target speed control mode.
Analog 1_Filter	25020110	0x1610	5	filter parameter of analog signal as $f=4000/(2\pi * \text{Analog1_Filter})$ time constant: $\tau = \text{Analog1_Filter}/4000$ (S)
Analog 1_Dead	25020210	0x1620	0	dead space of analog signal 1
Analog1_Offset	25020310	0x1630	0	offset of analog signal 1
analog1_out_polarity	25021410	0x1740	0	polarity of analog output 0: The same as the input polarity 1: In contrast to the input polarity
analog_speed_rpm at 10V	25021310	0x1730	1000	10V speed of Analog signal 1, is same to the speed without dead and offset.
Analog_Speed_Con	25020708	0x1670	1	Analog signal control speed, valid at operation mode 3 0x0: not valid 0x1: speed controlled by analog signal 1 0x10...0x1f: Ain1 control the "target speed control[x-0x10]"
Profile_Acce	60830020	0x4B00	9830	acceleration of trapezoidal curve
Profile_Dece	60840020	0x4C00	9830	acceleration of trapezoidal curve
Store_Data	2FF00108	0x2910	1	1: Store the parameters un-involves Motor. 10: initialize the parameters un-involves motor

6.5.4 How to simulate velocity mode with dead zone voltage

Requirement: -0.5V~0.5V are dead zone voltage, means the speed is 0 during the voltage from -0.5V~0.5V. And 10V is at 1000rpm, -10V is at -1000rpm.

Use analog channel 1 as AIN1 to control speed.

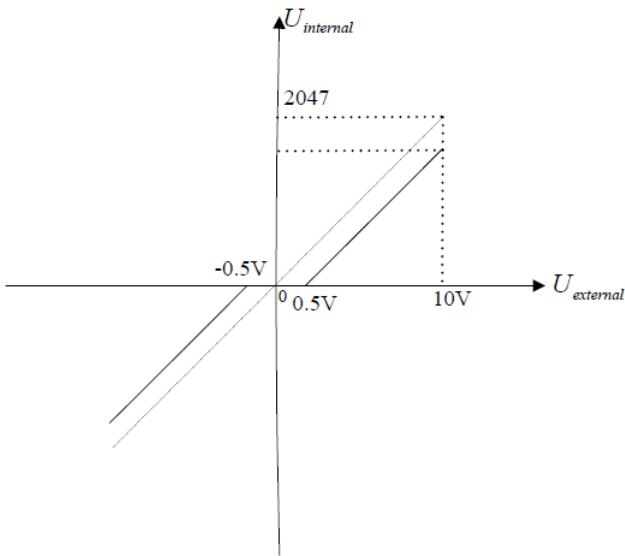

Figure 6-5 Control speed diagram 1

In fact the speed of 10V is 950rpm $(=(10V-0.5V)/10V*1000rpm)$ due to the dead zone voltage.

Base on chapter 6.5.3, the index have to change as below

Table 6-8 Parameter of Analog 1

Name	CANopen address	Modbus address	Value	Meaning
Dead zone of analog input 1	25020210	0x1620	0.5V (=410DEC)	Dead zone voltage of external analog signal 1

6.5.5 How to simulate profile velocity mode with dead zone voltage and offset

Requirement: offset voltage is 1V, Dead zone is 0.5V-1.5V, 10V 对应 1000rpm. And choose analog channel 1 as AIN1 control speed.

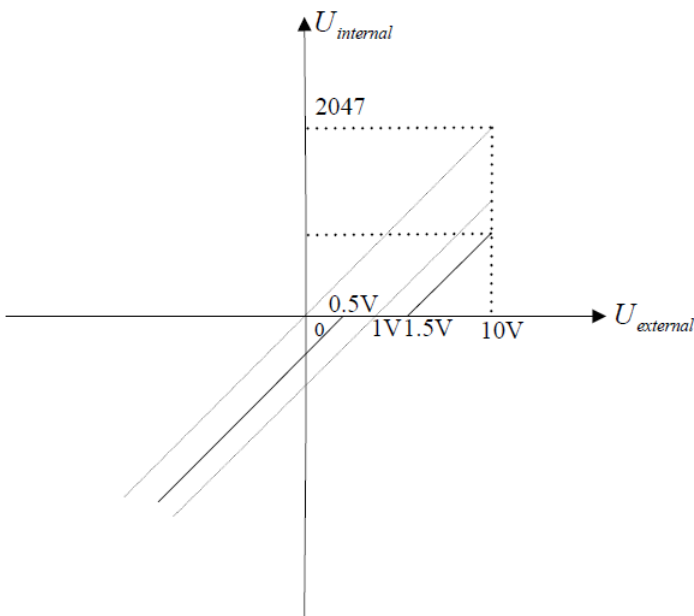

Figure 6-6 Speed mode diagram 2

In fact the speed of 10V is 850rpm $(=(10V-1V-0.5V)/10V*1000rpm)$, -10V is 1050rpm

$(=(-10V-1V+0.5V)/10V*1000rpm)$ duo to the dead zone and offset voltage.

Base on 6.5.3, the index have to change as below.

Table 6-9 parameters 2 in analog 1

Name	CANopen address	Modbus address	Value	Meaning
Dead zone of analog input 1	25020210	0.5V(=410DEC)	410	Dead zone voltage of external analog signal 1
offset of Analog input 1	25020310	1V(=819DEC)	819	offset voltage of external analog signal 1

6.6 Multi-target speed control mode 1

As for multi-target speed control mode is active the target position to control motor by input port. And there are 3 items to active it as below.

1. Multi-target speed control can run in 1 mode only.
2. The index to simulate provide velocity mode is 0, and at the same time, speed channel is invalid.
3. At least, there is 1 input port that defined multi-target position control as 0/1/2/3”.

Please input 0,1,2,3 which will be constituted the codes of binary system and selected as multi-target speed control from 0--15 channel, and the list as below.

Table 6-10 Binary system code

Multi-position 3	Multi-position 2	Multi-position 1	Multi-position 0	Din_Position	Din_Speed
0	0	0	0	0	0
0	0	0	1	1	1
0	0	1	0	2	2
0	0	1	1	3	3
0	1	0	0	4	4
0	1	0	1	5	5
0	1	1	0	6	6
0	1	1	1	7	7
1	0	0	0	8	8
1	0	0	1	9	9
1	0	1	0	10	10
1	0	1	1	11	11
1	1	0	0	12	12
1	1	0	1	13	13
1	1	1	0	14	14
1	1	1	1	15	15

Note: The signal is defaulted as 0 if do not select input signal 0, 1, 2, 3 for multi-target position.

6.6.1 Multi-Target position control

As for Motor, need to move 7 points position and request that the speed in 0 point position is 100rpm to arrive the pulse of 5000.

For the speed in 1 to 7 point position, is 150rpm, 175rpm, 200rpm, 300rpm, 325rpm, 275rpm and 460rpm speed to the pulse as 15000, 28500, -10500, -20680, -30550, 850, 15000 respectively.

Table 6-11 I/O Settings

Item	Value
DIN1	Drive enable
DIN2	Operation mode
DIN3	Set-point active
DIN4	Multi-position 0
DIN5	Multi-position 1
DIN6	Multi-position 2

Table 6-12 Position and speed settings

Name	CANopen address	Modbus address	Value	Meaning
Din_Pos 0	20200120	0x0C10	5000	Multi-position 0
Input multi-speed 0	20201120	0x0D10	100	Multi-speed 0
Din_Pos 1	20200220	0x0C20	15000	Multi-position 1
Din_Speed 1	20201220	0x0D20	150	Multi-speed 1
Din_Pos 2	20200320	0x0C30	28500	Multi-position 2
Din_Speed 2	20201320	0x0D30	175	Multi-speed 2
Din_Pos 3	20200420	0x0C40	-10500	Multi-position 3
Din_Speed 3	20201420	0x0D40	200	Multi-speed 3
Din_Pos 4	20200520	0x0C50	-20680	Multi-position 4
Din_Speed 4	20201520	0x0D50	300	Multi-speed 4
Din_Pos 5	20200620	0x0C60	-30550	Multi-position 5
Din_Speed 5	20201620	0x0D60	325	Multi-speed 5
Din_Pos 6	20200720	0x0C70	850	Multi-position 6
Din_Speed 6	20201720	0x0D70	275	Multi-speed 6
Din_Pos 7	20200820	0x0C80	15000	Multi-position 7
Din_Speed7	20201820	0x0D80	460	Multi-speed 7
Multi-speed/ Position switching delay	20203810	0x0F80	10	Multi-speed/Effective input delay after changed position
Din_Mode0	20203108	0x0F10	1	Input control Mode, low level mode.
Din_Mode 1	20203208	0x0F20	1	Input control Mode, low level mode.
Din_Control_Word	20203310	0x0F30	2F	Input enable signal as control_Word
Profile_Acce	60830020	0x4B00	50	set the acceleration (rps/s)
Profile_Dece	60840020	0x4C00	50	set the deceleration (rps/s)

Store_Data	2FF00108	0x2910	1	1:save the parameters without Motor 10:initialize the parameters without motor
------------	----------	--------	---	---

Note: the unit of multi-position is step, and for multi-speed and acceleration is rpm and rps/s, all of them changed to the unit of DEC with communication.

The steps of operation are as following.

1. Input enable to the drive.
2. Select the line position you want to move. And changed DIN4, DIN5, DIN6 level.
3. Set the active point and run the program.

6.7 Multi-speed 3

In generally, selected input signal to active target-speed to control motor. There are 3 item about it.

1. Multi-position control running is in 1 mode only.
2. The index to simulate speed control is 0, and the speed control channel is invalid.
3. At least, there is one input signal channel which defined multi-speed control 0/1/2/3.

Please input 0,1,2,3 which will be constituted the codes of binary system and selected as multi-target speed control from 0--15 channel, and the list as below.

Table 6-13 Binary system code

Multi-speed control 3	Multi-speed control 2	Multi-speed control 1	Multi-speed control 0	Input speed control
0	0	0	0	0
0	0	0	1	1
0	0	1	0	2
0	0	1	1	3
0	1	0	0	4
0	1	0	1	5
0	1	1	0	6
0	1	1	1	7
1	0	0	0	8
1	0	0	1	9
1	0	1	0	10
1	0	1	1	11
1	1	0	0	12
1	1	0	1	13
1	1	1	0	14
1	1	1	1	15

Note: The signal is defaulted as 0 if do not select input signal 0, 1, 2, 3 for multi-target position.

The parameter of multi-speed control 0-15, can select by IO port, and also will be achieved by analog signal to control it. The parameters of analog speed will be covered by the value of using analog signal.

Table 6-14 Parameter setting of multi-speed

Name	CANopen address	Modbus address	Value	Meaning
Analog_Speed_Con	25020708	0x1670	1x	<p>select the channel of analog speed</p> <p>0: not valid 1: AIN1, valid channel</p> <p>0x10...0x1f: Ain1 control the "target speed control[x-0x10]" is avalid</p>

Chapter 7 Communication Function

FM860 Stepping Motor Drive used 3 types protocol as CANopen and RS485 Modbus protocol and CANopen. The solution of selected controller as KINCOstep PC software to communicate to control drive in the field as uniaxial and multiaxial system replaced the old operation as pulse direction mode. And good at the points as reduce noise, cost down and so on.

Please pay attention as below if you selected FM860.

1. The I/O port DIN1 is defaulted as pulse input, DIN2 as direction input, DIN3 is motor free. Cancel the I/O settings by software if use communication control.
2. The index involves 2 types unit both for National standards and customized which can define by user's habit. Do not forget convert the unit to DEC when you write and read. And refer appendix VII to know more.
3. Take care command interval when use CANopen SDO to read/write and RS232 and RS485 to control. Make sure that only 1pcs drive send message at the same time and do the best for communication error, avoid the endless loop.
4. Some of index bit are out of size. In fact you can do not use it in real running. The index has the defaulted value for out of size part. For example, the motor don't accept the high speed duo to the target speed is 32bit. So the drive is limited the max value as 24576000(1500rpm), be the default value.

7.1 RS232

7.1.1 RS232 Hardware

How to connect from FM860 to PC, HMI

PC Desub	FM860 X2 (RJ45 connector)
RxD (2) -----	TXD (3)
TxD (3) -----	RXD (6)
GND (5) -----	GND (4)

7.1.2 RS232 Parameters

Table 7-1 Communication parameters

Name	CANopen address	Modbus address	Value	Meaning
ID_Com	0x100B0008	0x0600	1	drive ID set by DIP switch or PC software 注: 1) ID switch: SW6-SW1, select 1~63 or 0x2FE400 select 1~127。 2) Store and reboot the parameters if updated.
node_id_offset	0x2FE40008	0x2800	127	ID node is from 1 to127; Note: the setting is valid when SW6-SW1 is on OFF. And Store and reboot the parameters if updated.

RS232_Baud rate	0x2FE00010	0x2400	520	For RS232 Baud rate setting
				Value Baud rate
				2082 4800
				1041 9600
				520 19200
				259 38400
86 115200				
				Need to reboot
Store the parameter of control loop	0x2FF00108	0x2910	1	1: Store the parameter which changed. 10: Initialize the parameters which updated

7.1.3 Free transfer protocol

RS232 follow up the protocol both for master and slave. PC can send any message to Stepping Motor drive, and the drive which set address will return a message after calculated these data.

The formatting of RS232 transfer protocol is 10bytes.

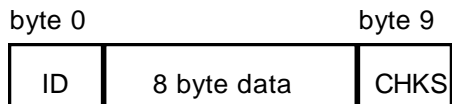

ID Com: Slave address

CHKS = -SUM(byte0,...,byte8), CHK: The last 2bit

PC sending:

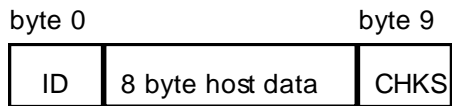

PC receive (returned from FM860):

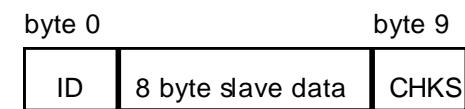

Note: Each 10bytes has a CHKS.

There isn't any return from FM860 if you send an error address which is not in the list. And the slave will find the address and check it out to you. The slave will do not reply to if the address is different with master's.

7.1.4 Data Protocol

Data protocol is different with transfer. The content of Data protocol is the 8 bytes middle of the 10bytes of transfer protocol. All value and function is shown by index and sub-index. The formatting are download and upload.

A: Download, means master write value to the object of slave, then will be error if download on the address which do not in the list.

Table 7-2 Master send message

10.5	Byte1	Byte2	Byte3	Byte4	Byte5	Byte6	Byte7
Byte0							

CMD	INDEX	SUB INDEX	DATA
-----	-------	-----------	------

CMD Specified the data transfer direction and data size.

0x23 Send 4bytes of data (bytes 4...7 involves 32bits)

0x2b Send 2bytes of data (bytes 4, 5 includes 16bits)

0x2f Send 1bytes of data (bytes 4 includes 8bits)

INDEX The address of send object

SUB-INDEX The address of send sub object

The order of the 4bytes the data is from low to high. For example, write 7650DEC, 607A0020 inc. and 7650 is 10 hex, 1DE2 is 16 hex. The object is required 4 bytes, the result of value is only 2bytes as 1D E2. so can add 0 on the high position as 00 00 1D E2.

DATA: byte4=E2

byte5=1D

byte6=00

byte7=00

Table 7- 3 Slave returned

Byte0	Byte1	Byte2	Byte3	Byte4	Byte5	Byte6	Byte7
RES	INDEX		SUB INDEX	RESERVED			

RES: Show the return of slave

0x60 Message send out successful

0x80 Error, figure out from the byte as 4...7

INDEX 16bytes address same to master

SUBINDEX 8bytes address same to master

RESERVED Backup

For example:

Master send download order to slave:

01 23 7A 60 00 E2 1D 00 00 03 (The order written to the target position of slave as 607A0020)

Slave return:

01 60 7A 60 00 E2 1D 00 00 C6

Meaning:

01— Slave address

60—the data bytes of transfer is 2bytes, saved by save byte4...byte5

byte4=E2, byte5=1D, byte6=00, byte7=00

So DATA= byte7 byte6 byte5 byte4 = 1DE2 (hex) =7650 DEC

B: Upload, means master read the object address of slave, and will be error if upload on the target position which do not in the list.

Master send message:

Byte0	Byte1	Byte2	Byte3	Byte4	Byte5	Byte6	Byte7
CMD	INDEX		SUB INDEX	RESERVED			

CMD Specified the data transfer direction

0x40

INDEX 16bytes address

SUBINDEX 8bytes address

RESERVED 4...7 bytes is useless

Slave received:

Byte0	Byte1	Byte2	Byte3	Byte4	Byte5	Byte6	Byte7
RES	INDEX		SUB INDEX	DATA			

RES Show the return of slave

0x43 Bytes as 4...7 involves 32bytes data

0x4B Bytes 4,5 involves 16bytes

0x4F Bytes 4 includes 8 bytes data

0x80 Error, bytes 4...7 with error

INDEX 16 bytes address same to master

SUBINDEX 8bytes address same to master

If data is correct, the byte4 ... byte7, is total of 4 bytes, stored the object of slave, the order is from low to high. And the correct value is byte7,byte6,byte5,byte4; if there is any error. The 4bytes is different.

For example:

01 40 7A 60 00 00 00 00 00 E5 (The target position is 607A0020)

Slave return:

01 43 7A 60 00 E2 1D 00 00 E3

Meaning:

01—Slave address is 1

43—Received data is 4bytes, saved by the byte4...byte5 middle of the 10bytes of the 4bytes of received data.

byte4=E2, byte5=1D, byte6=00, byte7=00

So DATA= byte7 byte6 byte5 byte4 = 1DE2 (hex) =7650 DEC

7.1.5 RS232 Communication address

Please refer chapter 6 to know more about each mode operation.

As for object address, visit appendix VII.

All of communication address is on appendix VII

RS232 Communication case, see RS232 Appendix III

7.2 RS485

7.2.1 RS485 Communication port

X1 interface of FM860 support both for RS485 and RS422. Can modify the drive parameter and monitor the status. Please refer the picture as following.

How to connecting RS485

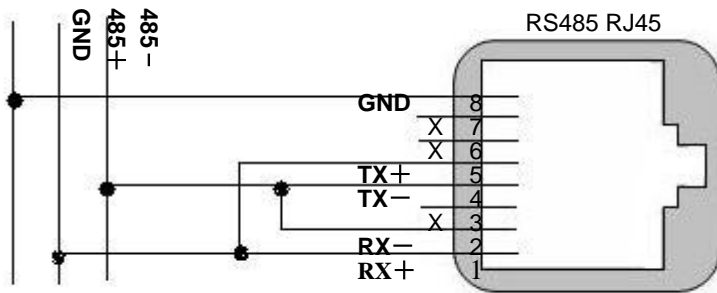

Figure7-1 RS485 connecting

How to connecting RS422

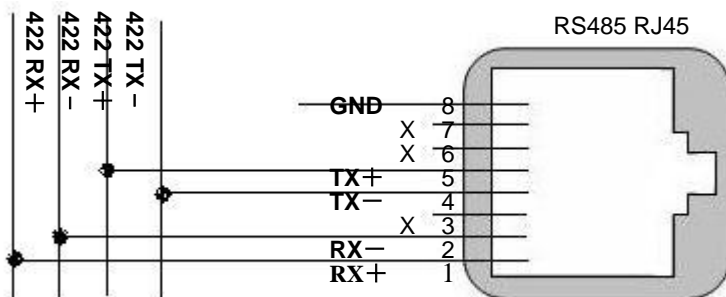

Figure7-2 RS422 connecting

PC Desub	FM860 RJ45(X2)
RX+ (2) -----	RX+ (1)
TX+ (3) -----	TX+ (5)
RX- (7) -----	RX- (2)
TX- (8) -----	TX- (4)
GND (5) -----	GND (8)

Note:1. All the pin of TX, RX of slave can be connected by series directly.

2. It need connect 120ohm termination resistors on the terminal both for the Master and the last one of slave.

AS for FM860, connect a termination resistor on the pins as SW9 and SW10.

3. FM Series needn't external 24V power supply to RS485.

4. Use net cable with Shielded to communicate and don't forget GND.

7.2.2 RS485 Communication parameters

Table 7-4 Communication parameters

Name	CANopen address	Modbus address	Value	Meaning												
ID_Com	0x100B0008	0x0600	1	Drive ID. Note: ID Switch: SW6-SW1, Selected 1~63 or 0x2FE400, selected 1~127. 2) Store and reboot the parameters if updated.												
Node_id_offset	0x2FE40008	0x2800	127	ID node is from 1 to 127; Note: the setting is valid when SW6-SW1 is on OFF. And Store and reboot the parameters if updated.												
RS485 Baud rate	0x2FE00010	0x2400	520	For RS485 Baud rate setting <table border="1"> <thead> <tr> <th>Value</th> <th>Baud rate</th> </tr> </thead> <tbody> <tr> <td>2082</td> <td>4800</td> </tr> <tr> <td>1041</td> <td>9600</td> </tr> <tr> <td>520</td> <td>19200</td> </tr> <tr> <td>259</td> <td>38400</td> </tr> <tr> <td>86</td> <td>115200</td> </tr> </tbody> </table> Need store and reboot	Value	Baud rate	2082	4800	1041	9600	520	19200	259	38400	86	115200
Value	Baud rate															
2082	4800															
1041	9600															
520	19200															
259	38400															
86	115200															
Store the Parameter of control loop	0x2FF00108	0x2910	1	1: Store the parameter which changed. 10: Initialize the parameters which updated												
Others			Fixed value	data bit = 8 stop bit = 1 No parity												

7.2.3 MODBUS RTU Communication Protocol

The RS485 of Stepping Motor Drive FM860, support MODBUS RTU communication protocol. Each 8-bit data consists of two 4-bit hexadecimal data. The data structure of the number which consist of hex is 11 bit character format, as for 8bit, the verification mode is CRC, the internal object is not continuous data register(mapped as 4X when read by PC)

Modbus Message RTU framing

A MODBUS message is placed by the transmitting device into a frame that has a known beginning and ending point. This allows devices that receive a new frame to begin at the start of the message, and to know when the message is completed. Partial messages must be detected and errors must be set as a result.

In RTU mode, message frames are separated by a silent interval of at least 3.5 character times. In the following sections, this time interval is required 3,5.

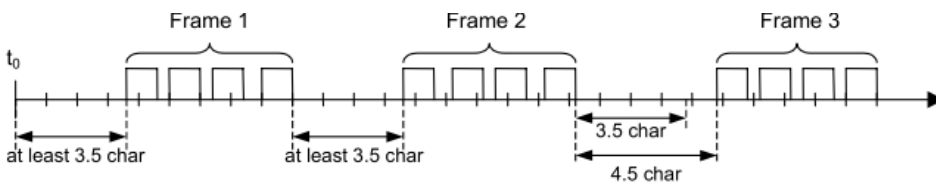

Figure 7-3 Frame formatting 1

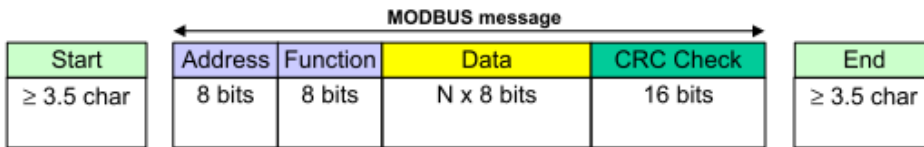

Figure 7-4 MODBUS communication formatting

The entire message frame must be transmitted as a continuous stream of characters.

If a silent interval of more than 1.5 character times occurs between two characters, the message frame is declared incomplete and should be discarded by the receiver.

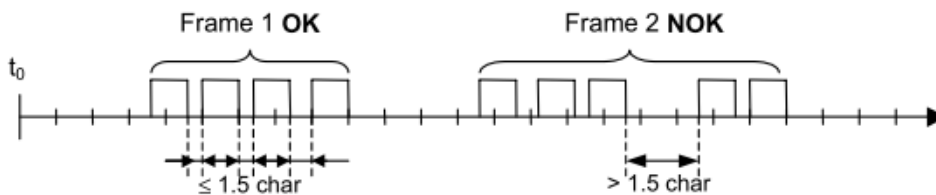

Figure 7-5 Frame formatting 2

7.2.4 Modbus Function code

Function code 0x03: Read data registers

Table 7-5 Request format:

Target station No	Function code	Start address upper byte	Start address lower byte	Read number upper byte	Read number lower byte	CRC
1byte	03	1byte	1 byte	1 byte	1 byte	2 byte

Table 7-6 Correct answer format:

Station number	Function code	Return data Number of bytes	Register 1 upper byte	Register 1 lower bytes	...	CRC
1bytes	03	1byte	1byte	1byte	...	2bytes

For Example:

Send message 01 03 32 00 00 01 8A B2 meaning

01: ID number

03: function code read data register

32 00: Read Objects' status word' 60410010 之 modbus address

00 01: Read word

8A B2: Check code

Return message 01 03 02 00 31 79 90 meaning

- 01: ID number
- 03: Function code Read data registers
- 02: Returns the number of byte data
- 00 31: Returns the status word data of object
- 79 90: Check code
- Function code 0x06: Write a single data register

Table 7-7 Request format:

Target station No.	Function code	Register address upper byte	Register address lower byte	Register value upper byte	Register value lower byte	CRC
1byte	06	1byte	1byte	1byte	1byte	2byte

Return formatting: The original will return if the setup is successful.

For example:

Send message 01 06 31 00 00 0F C7 32 meaning

- 01: ID number
- 06: Function code write word
- 31 00: Write object "control word" 60400010's modbus address, Data length is a WORD.
- 00 0F: Write data in hexadecimal 000F
- C7 32: Check code
- Function 0x10: Write multiple registers

Table 7-8 Request format:

Target station no.	Function code	Start address upper byte	Start address lower byte	Qty Upper byte	Qty lower byte	Number of bytes	Register value 1 Upper byte	Register value1 lower byte	...	CRC
1 byte	10	1 byte	1 byte	1 byte	1 byte	1 byte	1 byte	1byte	...	2 byte

Table 7-9 Correct answer format:

Target station no.	Function code	Start address upper byte	Start address lower byte	Number of bytes	Number of lower bytes 节	CRC
1byte	10	1 byte	1byte	1byte	1byte	2byte

For example:

Send message 01 10 6F 00 00 02 04 00 00 00 32 9B 88 meaning

- 01: ID number
- 10: Function node write word
- 6F 00: Write “target speed” 60FF0020’s modbus address, Data length is a WORD
- 00 02: Wirte 2 WORD
- 04: Data length is 4 BYTE (2 WORD)
- 00 00 00 32: Write data in hexadecimal as 00320000, Decimalism as 3276800, and converted to 200RPM
- 9B 88: Check code

Return message 01 10 6F 00 00 02 5C DC meaning

- 01: ID number
- 10: Function code read register
- 6F 00: Object address
- 00 02: Write WORD number
- 5C DC: Check code

It will response error if access the error number. And return a no-normal function code as 0x80+ function code.

Table 7-10 Abnormal answer format:

Station number	Abnormal function code	Error Code	CRC
1byte	1byte	1byte	2 byte

Table 7-11 Meaning of Error value

Error code value	Meaning
0x01	Function code do not support
0x02	Register address does not exist
0x03	Data error or register number is wrong
0x04	Write operation failed, including data range or object is read-only

7.2.5 Modbus Communication address

Please refer chapter 6 to know more about each mode operation.

As for object operation address, access appendix VII (RS485 do not support all in internal objects).

And RS485 communication case, please refer appendix II.

7.3 CANopen Bus communication

FM Series Stepping Motor Drive is standard CAN slaver device, and follow CANopen 2.0A/B protocol. Any PC can communicate with FM series Drive if the PC supported the protocol. As for FM series Stepping Motor Drive, selected object dictionary, which based on the standard as CANopen, all objects has clear definition of the functions. The objects is same to the memory address, part of object as speed and position can modify by external controller, and part of object as status and error messages just can modify by the

drive. The objects are as following.

	Index	Sub	Bits	Property	Meaning
For example	6040	00	16(=0x10)	RW	Device status control word
	6060	00	8(=0x08)	RW	Operating Mode
	607A	00	32(=0x20)	W	Target position
	6041	00	16(=0x10)	MW	Device status word

The property of object is as below

1. RW: Object can be read and written;
2. RO: Read only;
3. WO: Write only;
4. M: Can be mapped, similar to indirect addressing;
5. S: Objects can be stored in Flash-ROM area, and data don't be lost even power-off;

7.3.1 Hardware introducing

CAN communication protocol describes a way of transmitting information between devices, The definition of CAN layer is same as the open systems interconnection model OSI, each layer communicates with the same layer in another device, the actual communication takes place adjacent layers in each device, but the devices only interconnect by the physical media of the physical layer in the model. CAN standard define data link layer and physical layer in the mode. The physical layer of CAN bus is not strictly required, it can use a variety of physical media such as twisted pair Fibre. The most commonly used is twisted pair signal, sent by differential voltage transmission (commonly used bus transceiver). The two signal lines are called CAN_H and CAN_L. The static voltage is approximately 2.5V, then the state is expressed as a logical 1, also called hidden bit. It represents a logic 0 when CAN_H is higher than the CAN_L, we called it apparent bit, then the voltage is that CAN_H = 3.5V and CAN_L= 1.5V, apparent bit is in high priority. The standard CAN interface is as following figure:

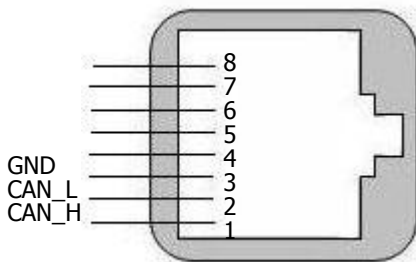

Figure 7-6 Standard CAN interface as RJ45

Table 7-12 RJ45 pins definition

Pin	Symbol	Description
1	CAN_H	CAN_H bus
2	CAN_L	CAN_L bus
3	CAN_GND	CAN_GND
4	NC	Empty

5	NC	Empty
6	NC	Empty
7	NC	Empty
8	CAN_GND	CAN_GND

Note:

1. All the pin of CAN_L, CAN_H can be connected by series directly.
2. It need connect 120ohm termination resistors on the terminal both for the Master and the last one of slave. AS for FM860, connect a termination resistor on the switch of SW9.
3. FM Series needn't external 24V power supply to CAN.
4. Please use the shield wires for communication cable, and make good grounding.
5. The max. distance at different baud rate are shown in following table.

Table 7-13 The max. Communication distance of baud rate

Communication speed	Communication distance
1Mbit/S	25M
500Kbit/s	100M
250Kbit/s	250M
125Kbit/s	500M
50Kbit/s	600M
25Kbit/s	800M

7.3.2 CANopen Communication parameters

Table 7-14 Communication parameters

Name	CANopen address	Modbus address	Value	Meaning
ID_Com	0x100B0008	0x0600	1	Drive ID. Note: ID Switch: SW6-SW1, Selected 1~63 or 0x2FE400, selected 1~127. 2) Store and reboot the parameters if updated.
Node_id_offset	0x2FE40008	0x2800	127	ID node is from 1 to127; Note: the setting is valid when SW6-SW1 is on OFF. And Store and reboot the parameters if updated
RS485 Baud rate	2F810008	0x2300	50	CAN Baud rate setting Value Baud rate 100: 1M 50: 500k 25: 250k 12: 125k 5: 50k

				Need store and reboot
Store the parameter of control loop	0x2FF00108	0x2910	1	1: Store the parameters which changed. 10: Initialize the parameters which updated

7.3.3 EDS

EDS (Electronic Data Sheet) file is one kind of code to connect from PLC to slave and identify the slave type as 401, 402 or 403. This file involves all information of slave as manufacturer, series number, software version, baud rate and so on, and same to the GSD file of Profibus. So you have to import EDS file to PC software first before configure the hardware.

7.3.4 SDO

SDO is used in the priority transmission of object between the devices, general use for the configuration, management of device as modify the parameter both for PID and PDO and etc. As for the data transmission is same to MODBUS, master send message and returned a response from slave. And the communication is good at parameter setting, not suitable for demanding real-time data transmission.

SDO is used to access the object dictionary of device in CANopen protocol. Visitor is called client, and object dictionary is accessed and provided CANopen device as server. The CAN message of client and the response of server always involves 8 bytes. And one request of client must have a response from the server.

SDO has 2 kinds of transmission process:

1. Expedited transfer: Up to 4 bytes of data transmission
2. Segmented transfer: Data length larger than 4 bytes

Table 7-15 SDO Basic Structure as below: Client→Server/Server→Client

Byte0	Byte1-2	Byte3	Byte4-7
SDO Command specifier	Object Index	Object sub-index	Data

SDO Command word contains the following information

1. Download/upload
2. Request /response
3. Segmented / expedited transfer
4. CAN frame bytes
5. For subsequent each segment alternately reset and set the toggle bit.

SDO achieved five requests and response.

1. Initiate Domain Download
2. Download Domain Segment
3. Initiate Domain Upload
4. Upload Domain Segment
5. Abort Domain Transfer

Download is for the write operation of object dictionary. Upload is for read operation. The details of SDO command word is as below.

Table 7-16 Initiate Domain Download

Initiate Domain Download_Byte0							Byte1-3	Byte4-7
Bit	7-5	4	3	2	1	0	Subject index and sub-index	
Client→	ccs=1	-	n		e	s		data
←Server	scs=3	-	-	-	-	-		-

Explanation:

n: is the bytes from 8-n to the seventh of meaningless data of message.

e: As for e=0, the message is delivered normally, and accelerating the delivery as e=1.

s: means whether specified data length. As for the value of 0, means No and Yes for the value of 1.

e=0, s=0: Keep by CiA.

e=0, s=1: The data byte is byte counter, byte 4 is the low part (LSB), byte 7 is high part (MSB). e=1: The data byte is the data to be downloaded.

For example

0x2f means the data to download 1byte (bytes 4 involves 8 bits)

0x2b means the data to download 2bytes (bytes 4,5 included 16bits)

0x23 is the data to download 4bytes (bytes 4,5,6,7 included 32bits)

0x21 is the Start frame to download over 4 bytes data, segmented downloading data

0x60 is download data successful

Table 7-17 Download Domain Segment

Download Domain Segment_Byte0							Byte1-7
Bit	7-5	4	3	2	1	0	
Client→	ccs=0	t	n			C	Data
←Server	scs=1	t	-	-	-	-	-

Explanation:

n : Meaningless data bytes. The value will be 0 if do not specified data length.

c : 0 = Subsequent segment requires download

t : Toggle bit, each segment is cleared and set alternately

For example

0x00/0x10 is segmented downloading data, involves 8bytes data (bytes 1-7)

0x0bmeans the last piece of data, involves 2 bytes data. (bytes 1, 2)

0x20/0x30 is segmented downloading successful.

Table 7-18 Initiate Domain Upload

Initiate Domain Upload_Byte0							Byte1-3	Byte4-7
Bit	7-5	4	3	2	1	0	Subject index and sub-index	
Client→	ccs=2	-	-	-	-	-		-
←Server	scs=2	-	n		e	s		data

Explanation: n, e, s: Same to download of Domain starting

For example:

0x40 is the data to ask upload subject

0x4f is the data to upload 1 byte. (bytes 4 involves 8 bits)

0x4b is the data to upload 2bytes. (bytes 4, 5 involves 16bits)

0x43 is the data to upload 4 bytes (bytes 4, 5, 6, 7 includes 32bits)

0x41 is the start frame to upload over 4bytes, and segmented uploading data

Table 7-19 Upload Domain Segment

Upload Domain Segment_Byte0							Byte1-7
Bit	7-5	4	3	2	1	0	
Client→	ccs=3	t	-	-	-	-	-
←Server	scs=0	t	n			c	data

Explanation: n, c, t : Same to download domain segment

0x60/0x70 is ask to upload segmented data

0x00/0x10 is the data to upload segmented data, includes 8bytes data (bytes 1-7)

0x19 is the last piece of data, involves 3 bytes data (bytes 1,2,3)

Table 7-20 Abort Domain Transfer

Abort Domain Transfer_Byte0							Byte1-3	Byte4-7
Bit	7-5	4	3	2	1	0	Subject index and sub-index	Error code
Client→/←Server	cs=1	-	-	-	-	-		

Example 1: Read control word parameters

table 7-21 Send SDO message

Identifier	DLC	Daten							
		0	1	2	3	4	5	6	7
0x600+Node_ID	8	40	40	60	00	00			

Table -22 Return SDO message

Identifier	DLC	Daten							
		0	1	2	3	4	5	6	7
0x580+Node_ID	8	4b	40	60	00	0006			

Notes: The command word is 0x40 when SDO send message

If the data is 1 byte, will return 0x4F

If the data is 2 bytes, will return 0x4B

If the data is 4 bytes, will return 0x43

If there is any wrong, will return a wrong code ad 0x80

Example 2: Modify control word parameters

Table 7-23 Send SDO message

Identifier	DLC	Daten							
		0	1	2	3	4	5	6	7

0x600+Node_ID	8	2b	40	60	00	002f
---------------	---	----	----	----	----	------

Table 7-24 Return SDO message

Identifier	DLC	Daten							
		0	1	2	3	4	5	6	7
0x580+Node_ID	8	60	40	60	00	00			

7.3.5 COB-ID

COB-ID is the specific way of CANopen communication. The full name is communication object identifier. The COB-ID defined the transport level. If you have the transport level, the controllers and drives can define the same transport level and contents. Then the data transmission is transparent and Both sides know the contents of the data to be transmitted.

As for the default ID allocation table is base on CANopen 2.0A, which defined 11bits CAN-ID (The COB-ID of CAN open 2.0B is 27bits) and involves the function code with 4 bits and the Note-ID with 7bits.

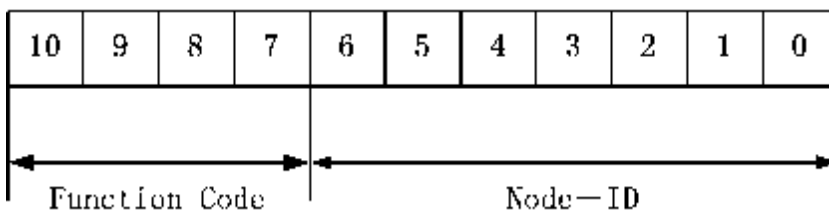

Figure 7-7 Formatting of CAN-ID distribution

Node-ID can define by defined by system integrators via the DIP switch of device. The scope of Node-id is from 1 to 127(0 is not allowed to be used)

Function Code is for data transmission, define the transport level of each PDO, SDO and message management, and function code is smaller, the priority is higher.

Table 7-25 allocation list for CAN identifiers in master/slave connection set predefined by CANopen

Broadcast objects			
Object	Function code (ID-bits 10-7)	COB-ID	The index of communication parameters in OD
NMT Module Control	0000	000H	-
SYNC	0001	080H	1005H, 1006H, 1007H
TIME SSTAMP	0010	100H	1012H, 1013H
CANopen master/slave Reciprocity objects			
Object	Function code (ID-bits 10-7)	COB-ID	The index of communication parameter in OD
EMCY	0001	081H-0FFH	1024H, 1015H
TPDO1(send)	0011	181H-1FFH	1800H
RPDO1(receive)	0100	201H-27FH	1400H
TPDO2(send)	0101	281H-2FFH	1801H
RPDO2(receive)	0110	301H-37FH	1401H
TPDO3(send)	0111	381H-3FFH	1802H

RPDO3(receive)	1000	401H-47FH	1402H
TPDO4(send)	1001	481H-4FFH	1803H
RPDO4(receive)	1010	501H-57FH	1403H
SDO(send/server)	1011	581H-5FFH	1200H
SDO(receive/Client)	1100	601H-67FH	1200H
NMT Error Control	1110	701H-77FH	1016H-1017H

Note:

1. COB-ID is smaller, the priority is higher.
2. The function code of COB-ID is fixed formatting;
3. COB-ID 为 00H、80H、100H、701H-77FH、081H-0FFH are systems management formatting.

7.3.6 PDO:

Process data object can send 8 bytes data one time. No other pre-set protocols, use for the high-frequency switching data. PDO transmission mode used a new data exchange, the devices have to define the area both for data sending and receiving. And send related data to each other directly during the data exchange, which reduced more time to improve the efficiency of bus communication. So resulting in a high bus utilization.

1) Send PDO (TPDO)

Send PDO, for Stepping motor drive, is send out data, and receive by PLC. The function code as COB-ID of PDO is

- 1、 0x180+Station No. of Stepping motor drive
- 2、 0x280+ Station No. of Stepping motor drive
- 3、 0x380+ Station No. of Stepping motor drive
- 4、 0x480+ Station No. of Stepping motor drive

2) Receive PDO (RPDO)

Receive PDO, as for Stepping motor drive, is receive data and which sent by PLC. The function code as COB-ID of sending PDO is

- 1、 0x200+ Station No. of Stepping motor drive
- 2、 0x300+ Station No. of Stepping motor drive
- 3、 0x400+ Station No. of Stepping motor drive
- 4、 0x500+ Station No. of Stepping motor drive

The design of FM series Stepping motor drive is follow up CANopen 2.0A. It support CANopen 2.0B also. And meanwhile, if the 8 PDO are un-enough, user can define a new PDO as 0x43FH for station 1, controller and drive are also follow it.

3) PDO Transport Type

PDO have 2 type transport mode:

SYNC: Transmission is triggered by the synchronization message (Transmission type:0-240)

In this transmission mode, controller must have the ability to send synchronous messages (the message is sent periodically at a maximum frequency of 1KHz), and servo will send after receiving the synchronous

message.

Acyclic: Pre-triggered by remote frame or by specific event of objects specified by the equipment sub-protocol. In this mode, Stepping Motor Drive will send out data in PDO after receiving SYNC message.

Cyclic: Triggered after sending 1 to 240 SYNC message. In this mode, Stepping Motor drive will send out data in PDO after receiving N(pcs) SYNC messages.

ASYNCTransmission Type:254/255): Slave sends out message automatically as soon as the data change, and it can define an interval time between two messages which can void the one in high priority always sending message.(smaller, the priority is higher. the smaller number of PDO, the higher its priority)

As for FM series, just support ASYNC transmission mode right now. It will be added different transmission later.

4) PDO Inhibit time

Each PDO can define a inhibit time. That is the minimum interval time between two continue PDO transmission. It is used to avoid the PDO in higher priority always occupying the communication. The inhibit time is 16bits un-signed integer. Its unit is 100us.

5) For example:

Use TPDO to update Target-speed by the object as 0x1A00. And selected 0x1800 to configure the property of mapping object as 0x1A00.

Table 7-26 Property of object 0x1800

Property of object 0x1800		
Sub-index	Value	Meaning
0	3	The object has 3 sub-index
1	0x250+Node_ID	Node-ID
2	254	Asynchronous transmission
3	50	Disable transmission time interval

Table 7-27 Mapping of 0x1A00 TPDO

Mapping of 0x1A00 TPDO		
Sub-index	Value	Meaning
0	1	1 object are mapped to PDO
1	0x60ff0020	Object 0x60ff, sub-index 0x00, consisted of 32 bits

Table 7-28 The formatting of Send message:

Identifier	DLC	Date							
		0	1	2	3	4	5	6	7
0x250+Node_ID	8	Target-speed							

7.3.7 Boot-up Process

In the network initialization process, CANopen support both for extended boot-up and the process of minimum boot-up. And for extended boot-up is optional, but for minimum boot-up must be supported by each node. And the both of boot-up can exist in the same network at the same time. The node must be support extend boot-up process if selected the DBT of CAL to configure ID,

The boot-up process is shown as following.

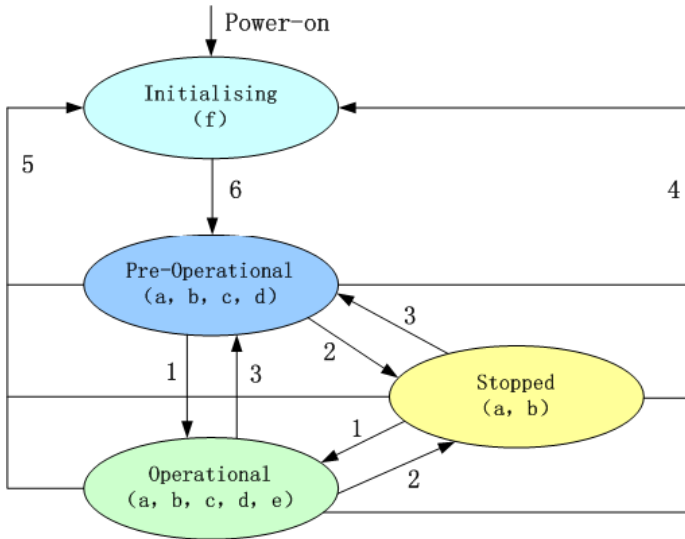

Figure 7-8 Node status conversion

Note: The letters in the parenthesis means the objects which can used in this status:

- a. NMT , b. Node Guard , c. SDO , d. Emergency , e. PDO , f. Boot-up

State transition(1—5 are sent by NMT service)

- 1: Start_Remote_node
- 2: Stop_Remote_Node
- 3: Enter_Pre-Operational_State
- 4: Reset_Node
- 5: Reset_Communication
- 6: Initialization finish, enter pre-operational status and send boot-up message.

NMT services can make all or some nodes into different work state at any time. The CAN message of NMT service is consisted of 2 bytes as COB-ID=0. the first byte represents the type of service requests as NMT comm. And specifier, the second byte is Node-ID or 0.

7.3.8 NMT Module Control

NMT management message can be used to change the modes. Only NMT-Master node can send NMT module control message, and all slave must support NMT module control service, meanwhile NMT module control message needn't response. The format of NMT message is as follows.

Table 7-29 NMT-Master → NMT-Slave(s)

COB-ID	Byte 0	Byte 1
0x000	CS	Node-ID

When Node-ID is 0, then all the NMT slave device are addressing, CS is command, its value is as follows.

Table 7-30 Command value of CS

Command	NMT service
0x01	Start Remote Node

0x02	Stop Remote Node
0x80	Reset Node
0x81	Reset Node
0x82	Reset Communication

For example, if you want a node in the operational status to return to the pre-operational status, then the controller needs to send following message.

Table 7-31 Controller Message

COB-ID	Byte 0	Byte 1
0x000	0x80	0x02

7.3.9 Protection mode (Supervision Type)

Supervision type is that master selected what kind of check type during operation. And there are two kind of type as Heartbeat message and Node guarding to check the fault of slave and handle it.

Heat beat message:

Heat beat message, Slave send message to master cyclically during supervision time, if master hasn't received message from slave after heartbeat time then master will consider slave as error.

Heartbeat Producer → Consumer(s)

Table 7-32 Heat beat message

COB-ID	Byte 0
0x700 + Node-ID	Status

Table 7-33 Status value

Value	Meaning
0x00	Boot-up
0x04	Stopped
0x05	Operational
0c7f	Pre-operational

The Boot-up message is the first heat beat if the node When the Heartbeat activated.

Node guarding: Master send message to slave cyclically during supervision time, slave return it immediately. If master don't receive the response from slave after supervision time. Then master will consider the error of slave. NMT-Master Node send remote frame(without data)as below.

NMT-Master → NMT-Slave

COB-ID
0x700+Node_ID

NMT-Slave Node send message as following

Table 7- 34 NMT-Master → NMT-Slave message

COB-ID	Byte 0
0x700 + Node-ID	Bit 7 : toggle bit Bit6-0 : Status

As for Byte 0, involves a toggle bit(bit7), and the toggle bit is turned to configure the 0 or 1 in node protection each time. The first node protection of toggle bit is "0". And the bit from 0 to 6 means node status.

Table 7-35 Status value definition

Value	Meaning
0	Initializing
1	Disconnected *
2	Connecting *
3	Preparing*
4	Stopped
5	Operational
127	Pre-operational

Note: The parts with the icon as *, will be provided to the node with extend boot-up. Please pay attention, the status 0, is never shown for node protection.

A node can not support Node Guarding and Heartbeat protocol at the same time. You can select one of them.

7.3.10 CANopen Communication Address of Stepping Motor Drive Parameters

Please refer Chapter 6 to know more about each operation mode.

Please access object list as Appendix VII in Chapter 9 for common object address

Please refer all communication address as Appendix VII

Please refer Chapter 9 as Appendix I of CANopen communication case.

Chapter 8 Alarm and Troubleshooting

8.1 Alarm Messages

LED of ERP light flashes red, it indicates that the drive failure alarm. As for details, please refer the code list as below. And the alarm information is hex.

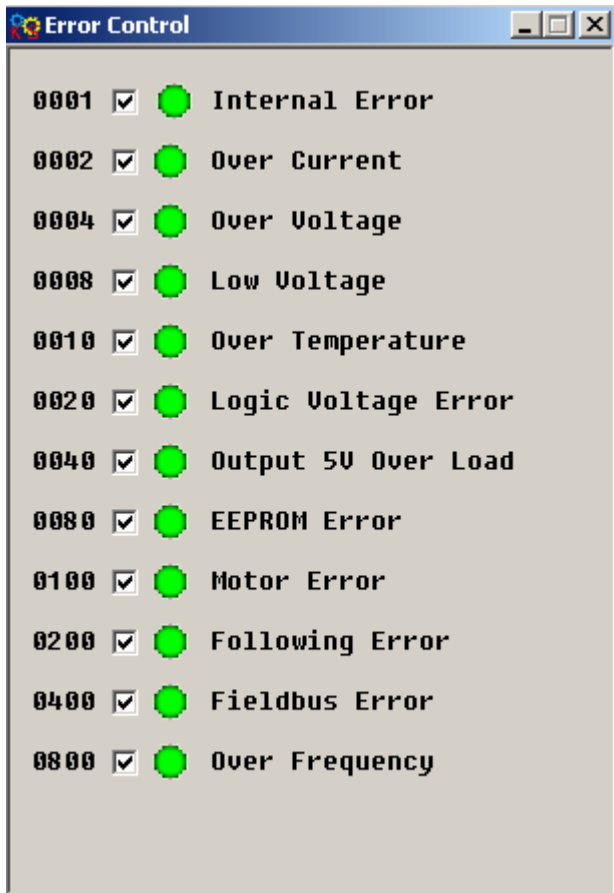

Figure 8-1 Real time error

Table 8-1 Error alarm and solution

Alarm	LED		Alarm	Solution
	RUN	ERR		
Internal Error	Slow flash	Fast flash	1. Motor type is wrong for driver 2. Driver's problem	1. Please refer FM860 Field bus Control Stepping Motor Driver Operating guide 2. Contact manufacturer
The driver output short circuit	Extinguished	Fast flash	1. The short circuit of Motor phase 2. Driver's problem	1. Check Motor wiring 2. Contact manufacturer
Over voltage of driver bus	Fast flash	Fast flash	1. The voltage of power supply is too high 2. The energy of high speed stop occasions is too high	1. Check power supplier 2. Add braking resistor
Low voltage of	Extinguished	Open	1. The voltage of power supply is too lower	1. Check power supply 2. Reduce acceleration

driver bus			2. Rapid start	
Over temperature	Extinguished	Slow flash	The power module of driver is over than 80 °C	Check the temperature is whether larger than 40 °C
EEPROM Error	Fast flash /Slow flash	Open	1. cause to update the driver underlying firmware 2. Driver's problem	Initialize the parameters first, and save and reboot driver
Motor Error	Fast flash	Open	1.unconnected motor or connected wrong 2. write wrong motor parameters	1. Check motor wiring 2.Please refer FM860 Field bus Control Stepping Motor Driver Operating guide
Logic voltage Error			The Internal logic voltage both for 15V or 5V is out of the scope	Contact manufacturer
Overload of Output 5V current			The output of 5V current is too large	Check the wiring of 5V load
Following Error	Slow flash	Open	Overload or get stuck	Check load or reduce acceleration
Field bus Error			Bus communication is closed	Check bus communication parameters
Input pulse frequency is too high			Input pulse frequency is over the max. value.	Check whether the input pulse frequency is larger than the max. value

Note: the frequency both for slow flash and fast are 0.5Hz and 5Hz.

Chapter 9 Appendix

9.1 Appendix 1 CANopen Bus communication case

9.1.1 CANopen communication between FM860 and Kinco F1 PLC

1. Wiring diagram

F1 PLC CAN port FM860 CAN (X1A, X1B)

CAN_L (2) ----- CAN_L (2)

CAN_H (7) ----- CAN_H (1)

GND (3) ----- GND (3)

■Note:

- a. It must use series connection for multiple slaves.
 - b. CAN1 and CAN2 of F1 PLC are divided, can be used at the same time.
 - c. There are terminal resistors with PLC and FM860, set by DIP switch.
2. Parameter Setting. For FM860 baud rate and station number and so on, please refer to chapter 7.3 CANopen Bus Communication.
3. Software program
- a. Create a new project, select Kinco F122-D1608T and click OK.

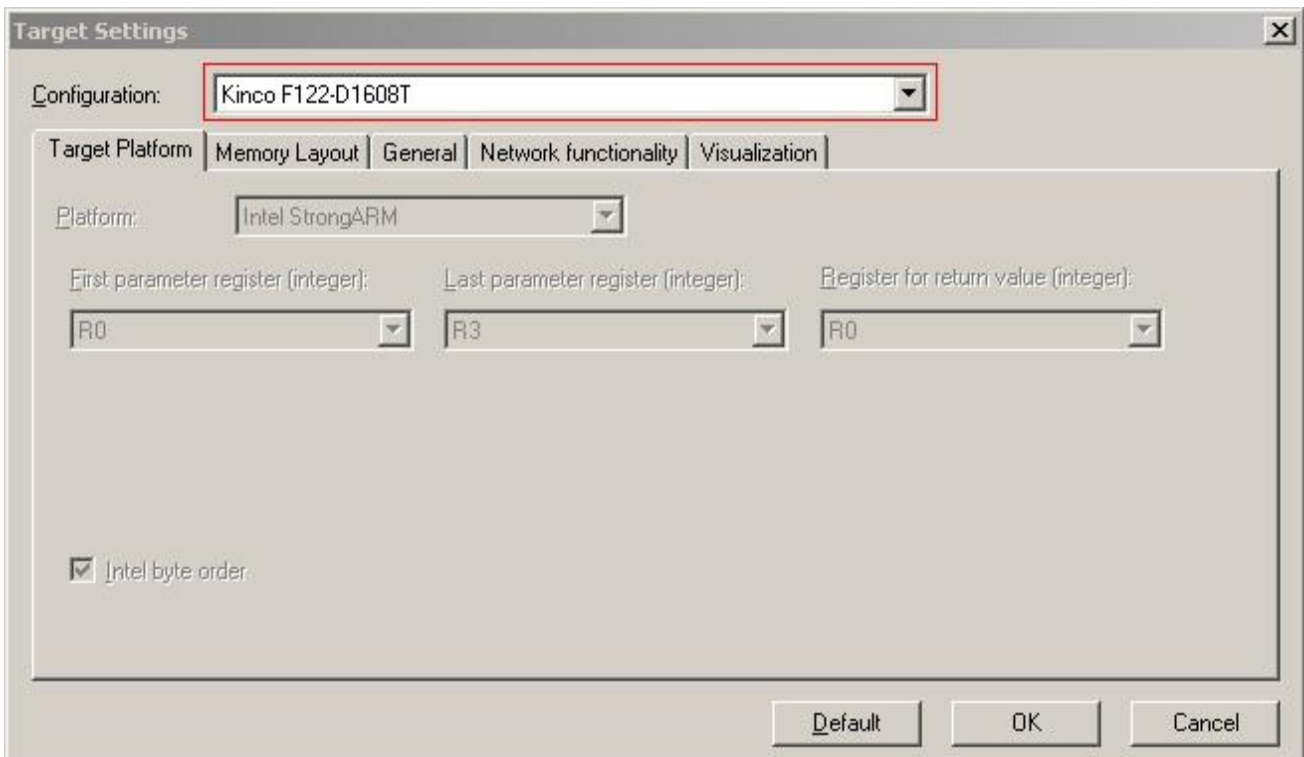

- b. Select program language according to your habit. Then click OK.

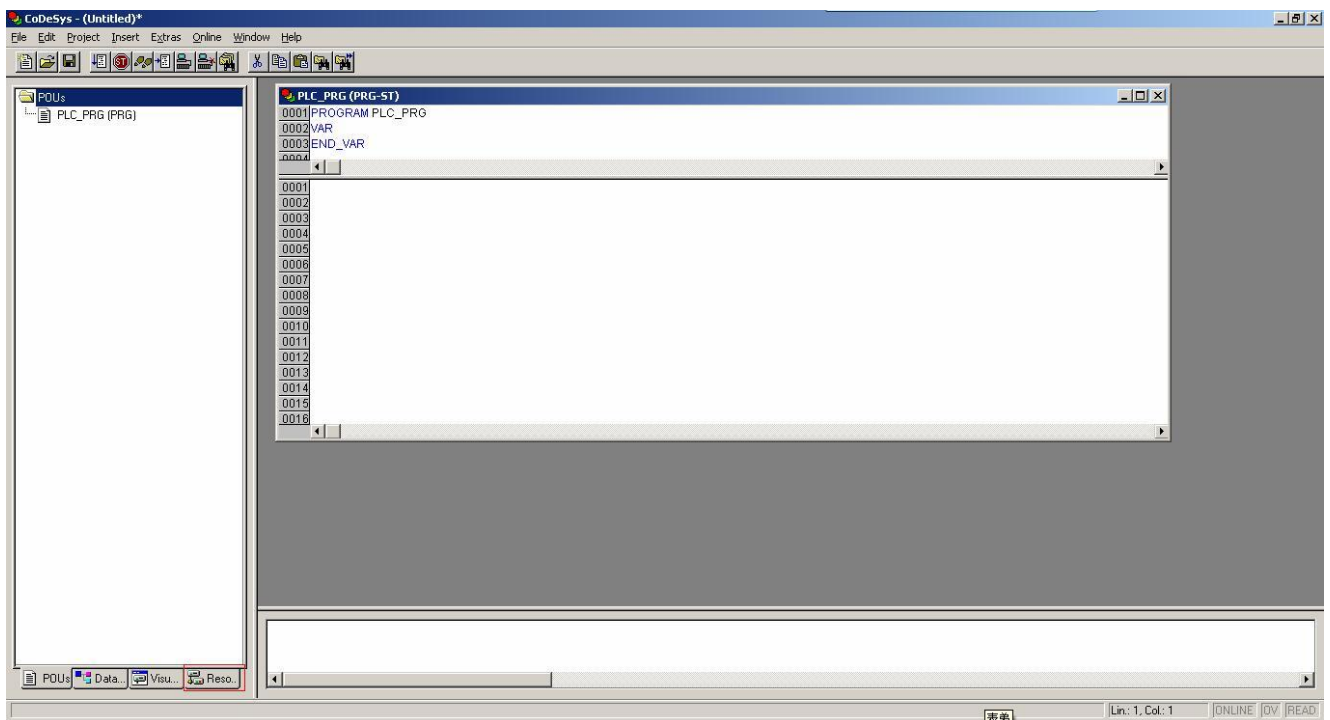
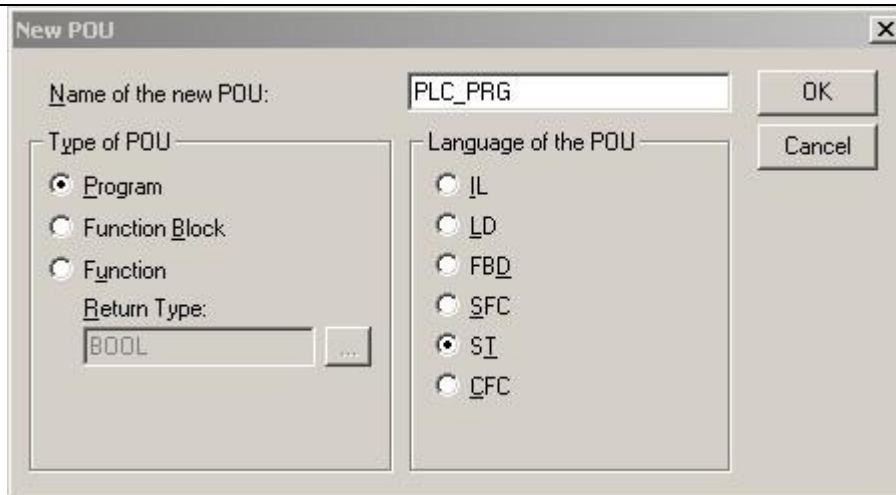

c. It will show us a window as below after you finished step2. Then select “Resources” option and get into PLC Configuration page.

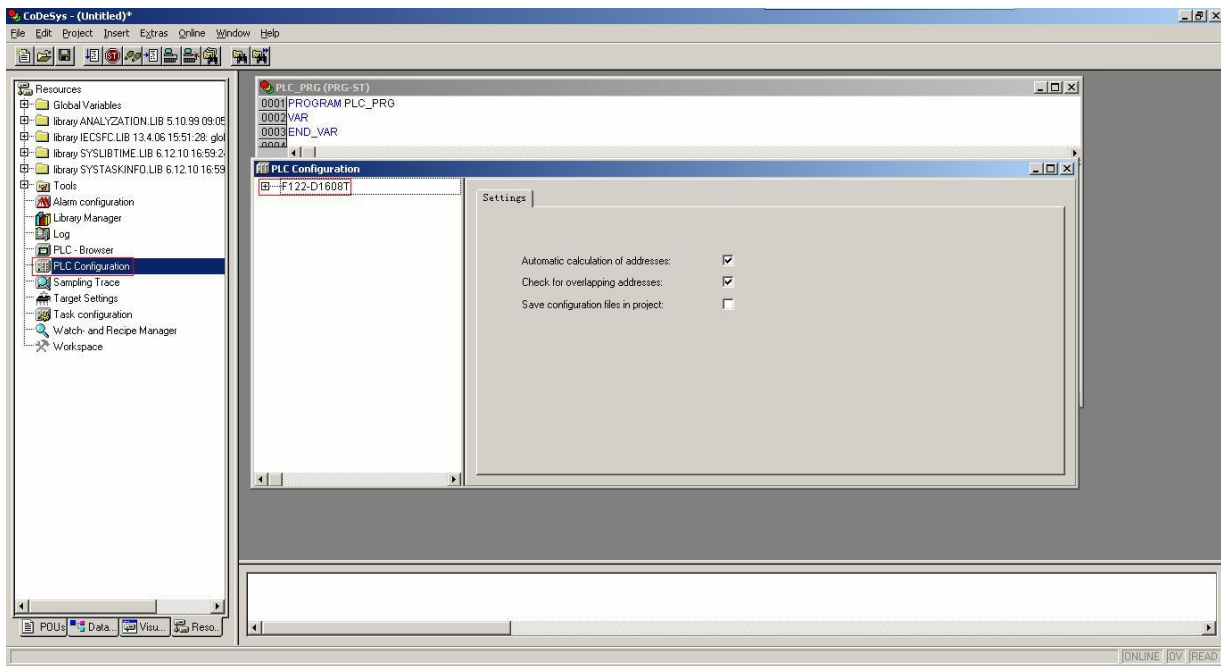

d. Click “Extras→ add configuration file”, then show us a dialog to add EDS file of FM860.



e. There are 2 CAN ports in F1 PLC, both of them can be used as master. Set baud rate and Node-ID for CAN port. If you need synchronous message, please click “activate”, then set transmission cycle synchronization message and COB-ID in “Com. Cycle period”.

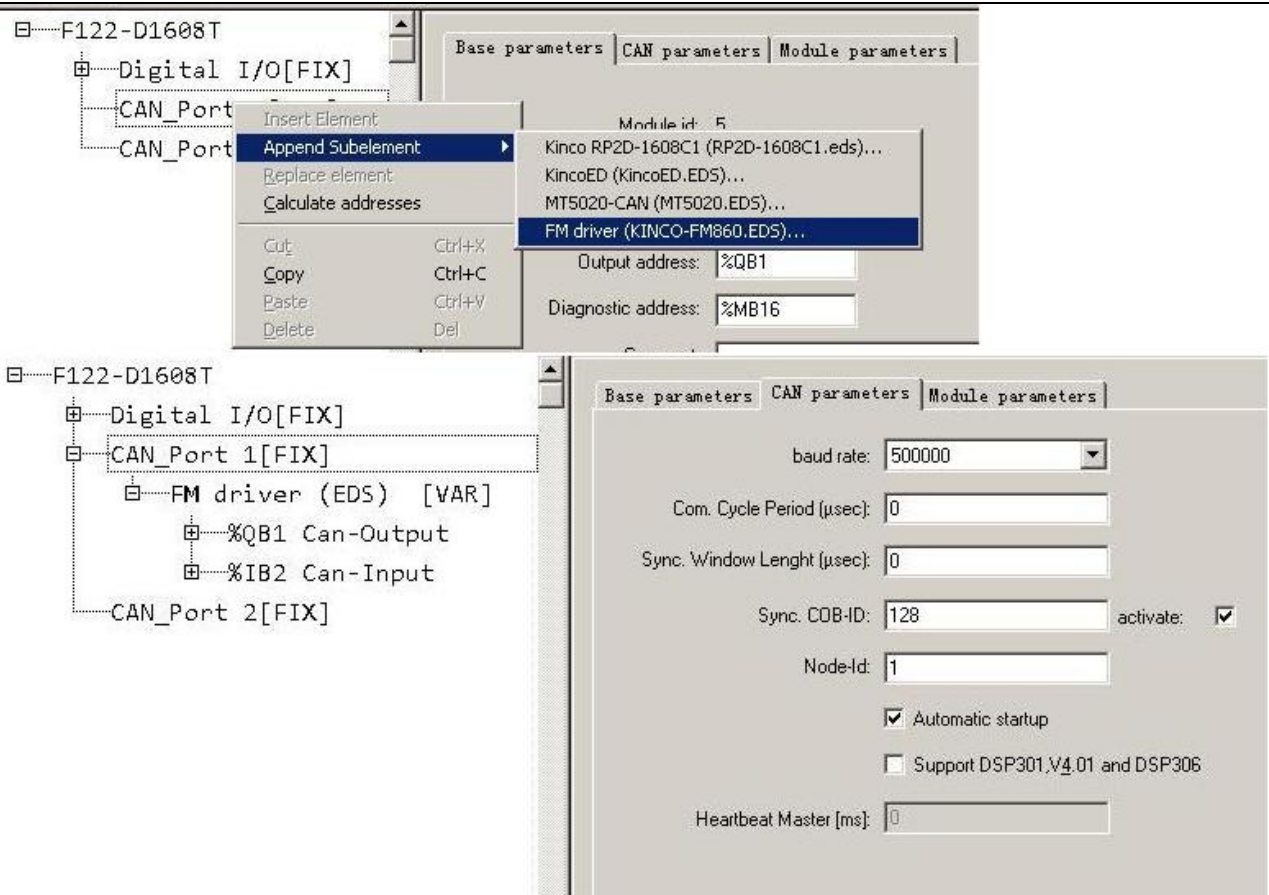

f. Right click “CANMaster” and select “Append FM Drive” to add slaves. Then set parameters such as Node ID, Node guarding, RX-PDO and TX-PDO.

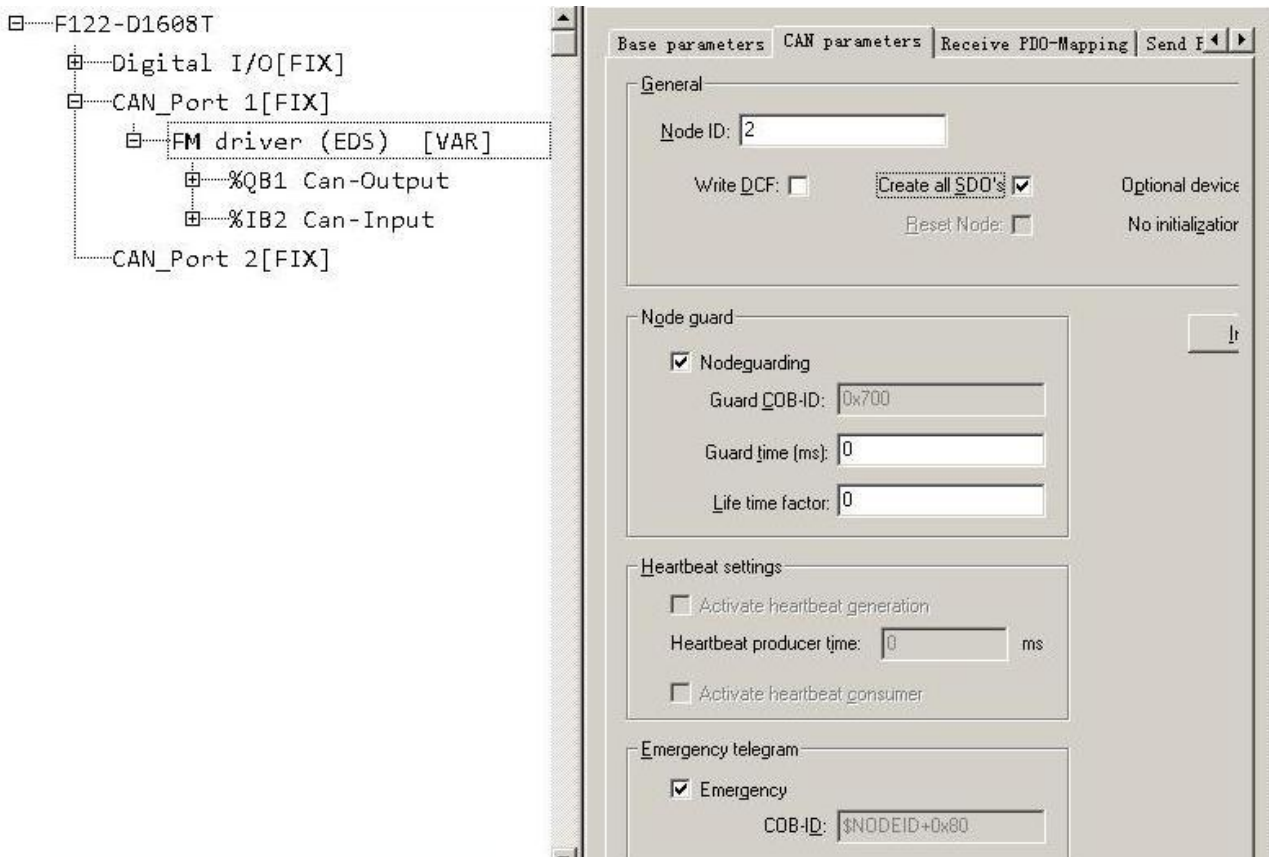

g. Configure the PDO objects of slave according to the requirement.

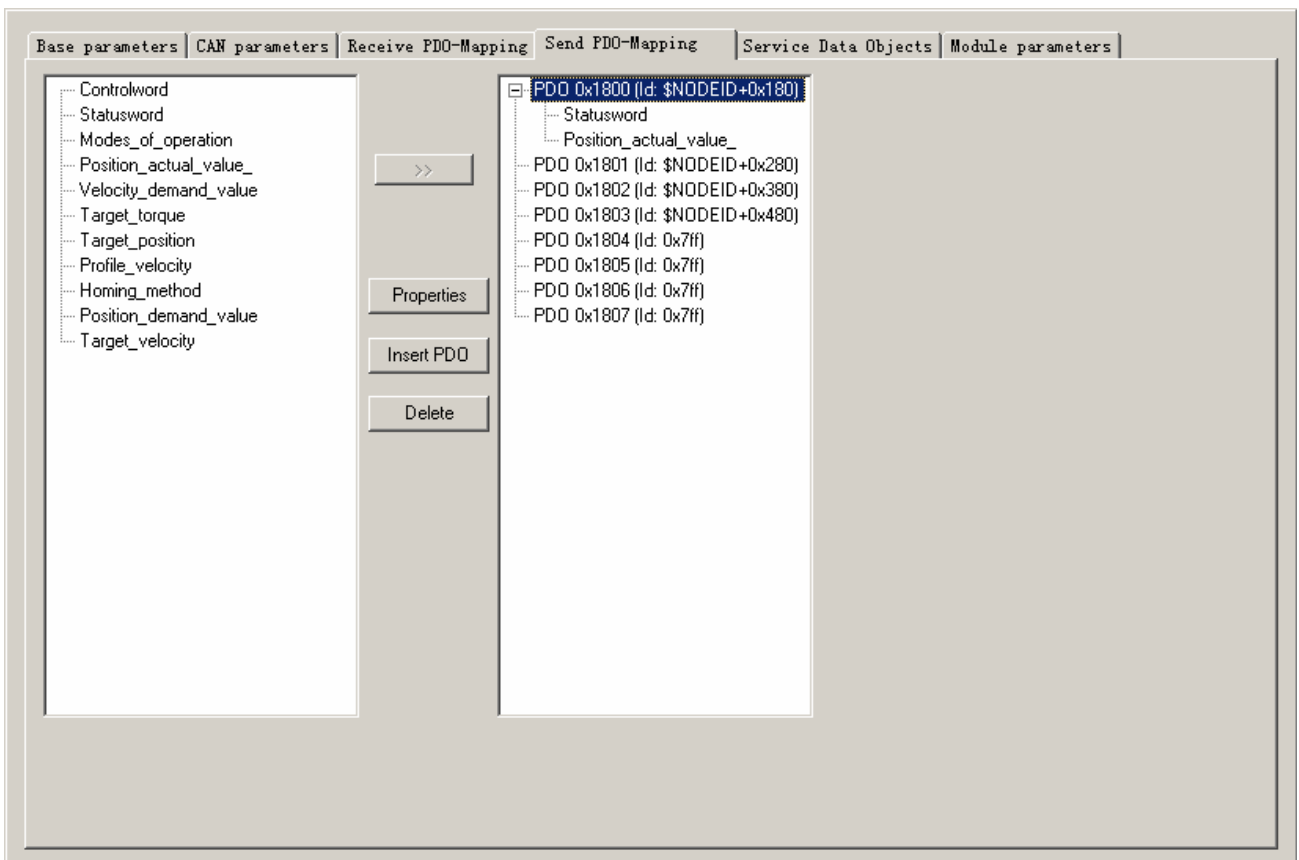
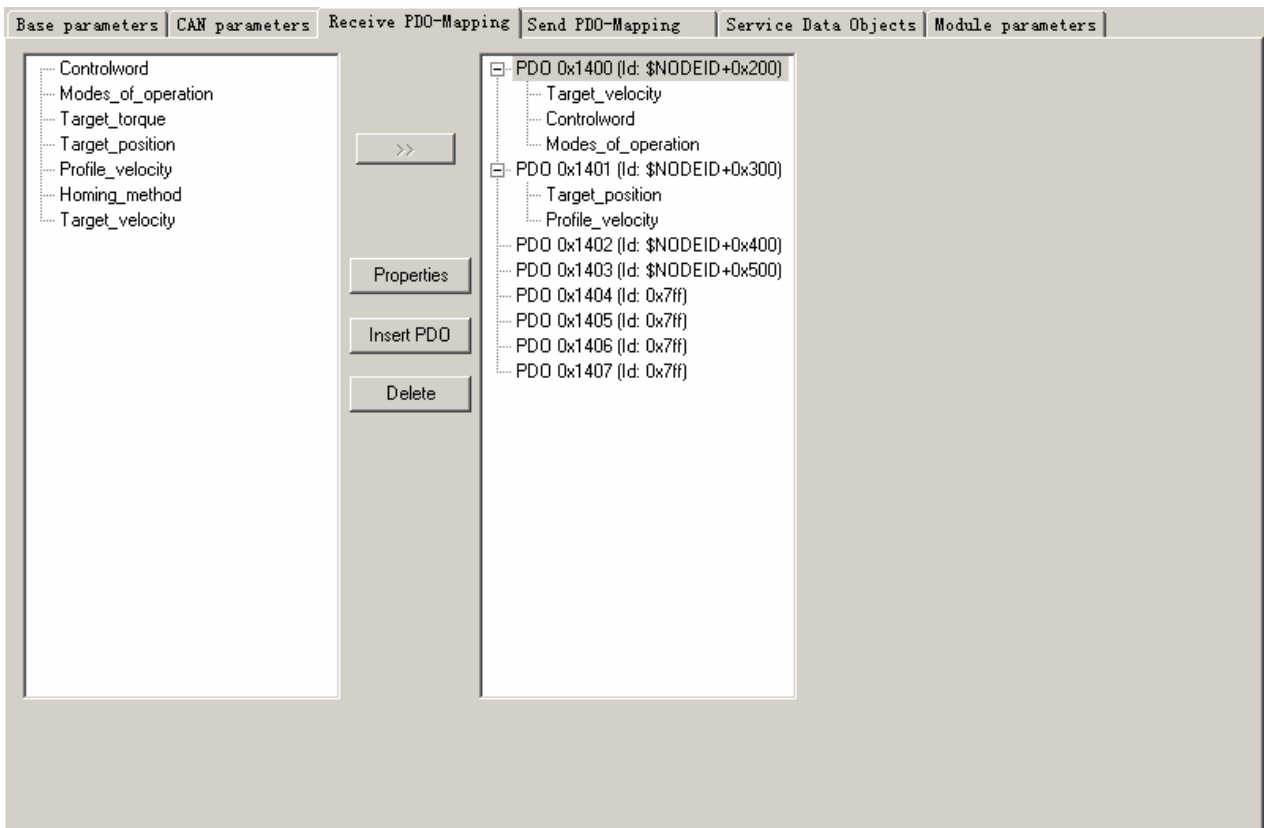

h. After configure all the parameters, there will be all the registers corresponding to all the OD as shown in following figure. For example, the register for control word is QW4, and the register for status word is IW1.

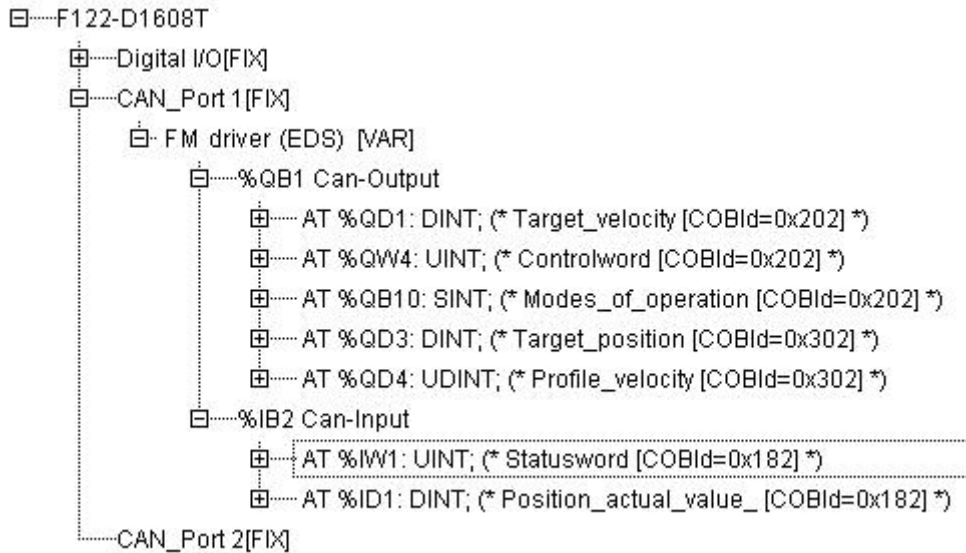

i. refer to such procedure to configure several slaves, then you can start to program to control FM860. As for Variable name, can define it first for program or use the address directly.

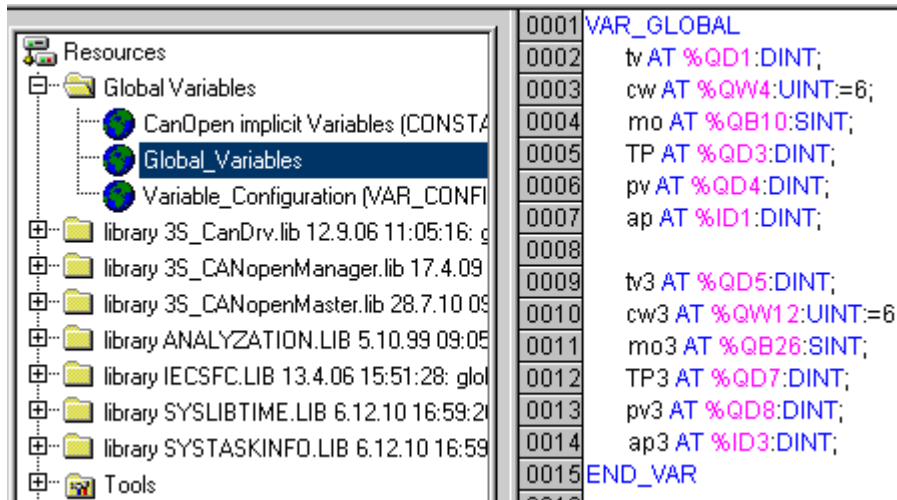

j. The program is as bellows figure. More details please refer to the chapter 6 Mode operation.(and pay attention to Chapter 7 before you do the control operation. And you have to initialize Stepping drive control word as “F” when created the communication between F1 and CAN, otherwise Stepping drive does not respond to other commands.

```

0001 PROGRAM JD2
0002 VAR
0003     m1: BOOL;
0004     m2: BOOL;
0005     spv: DINT;
0006     m3: BOOL;
0007     m4: BOOL;
0008     m5: BOOL;
0009     actual_pos: DINT;
0010     m6: BOOL;
0011 END_VAR
0001 actual_pos:=ap;
0002 (* power off*)
0003 IF m1=1 THEN
0004 tv:=27300;
0005 cw:=6;
0006 mo:=3;
0007 m1:=0;
0008 END_IF
0009 (* velocity*)
0010
0011 IF m2=1 THEN
0012 tv:=273000;
0013 cw:=47;
0014 mo:=3;
0015 m2:=0;
0016 END_IF
0017
0018 (* absolute position*)
0019 IF m3=1 THEN
0020 tp:=0;
0021 pv:=2730000;
0022 cw:=63;
0023 mo:=1;
0024 m3:=0;
0025 END_IF

```

k. If the objects are not in the EDS file or not commonly use, we can use SDO to read and write these objects as shown in following figure.

```

0001 PROGRAM sdo
0002 VAR
0003     sdo1:CanOpenSendSDO;
0004     m9: BOOL;
0005     m10: BOOL;
0006     sdo2: CanOpenSendSDO;
0007     ww: ARRAY [0..7] OF BYTE;
0008     val: DWORD;
0009 END_VAR
0001 (*SDO写速度*)
0002 sdo1( Enable:= m9,(*使能*)
0003     wDrvNr:= 0, (*总线接口号, CAN1固定为0*)
0004     ucNodeId:=2,(*从站站号*)
0005     wIndex:=16#60FF,(*OD INDEX*)
0006     bySubIndex:=16#00,(*subINDEX*)
0007     ucModus:= 16#23,(*use 16#23 FOR 4-BYTE-write-request
0008         use 16#27 FOR 3-BYTE
0009         use 16#2B for 2-byte
0010         use 16#2F for 1-byte
0011         use 16#21 FOR downloading more than 4 bytes using the segmented transfer*)
0012     ucByte0 :=16#10,
0013     ucByte1 :=16#A8,
0014     ucByte2 :=16#29,
0015     ucByte3 :=00);
0016 (*SDO读实际速度*)
0017 sdo2(Enable:= m10,(*使能*)wDrvNr:= 0,(*总线接口号, CAN1固定为0*)ucNodeId:=2,(*从站站号*)
0018     wIndex:=16#606C,(*OD INDEX*)
0019     bySubIndex:=16#00,(*subINDEX*)
0020     ucModus:=16#40);(*SDO-mode, use 16#40 for read-request.*)
0021 IF sdo2.bAnswerRec THEN
0022     val := SHL(BYTE_TO_DWORD(sdo2.ucAnswerBytes[7]),24);
0023     val := val + SHL(BYTE_TO_DWORD(sdo2.ucAnswerBytes[6]),16);
0024     val := val + SHL(BYTE_TO_DWORD(sdo2.ucAnswerBytes[5]),8);
0025     val := val + BYTE_TO_DWORD(sdo2.ucAnswerBytes[4]);
0026 END_IF

```

9.1.2 CANopen Communication between FM860 and Peak CAN

Peak company has many kinds of CAN adapter such as ISA, PCI, USB-CAN and so on. This example is to use PCAN-USB connected to FM860.

1. Please refer PCAN-USB hardware manual to install.
2. Wiring connecting

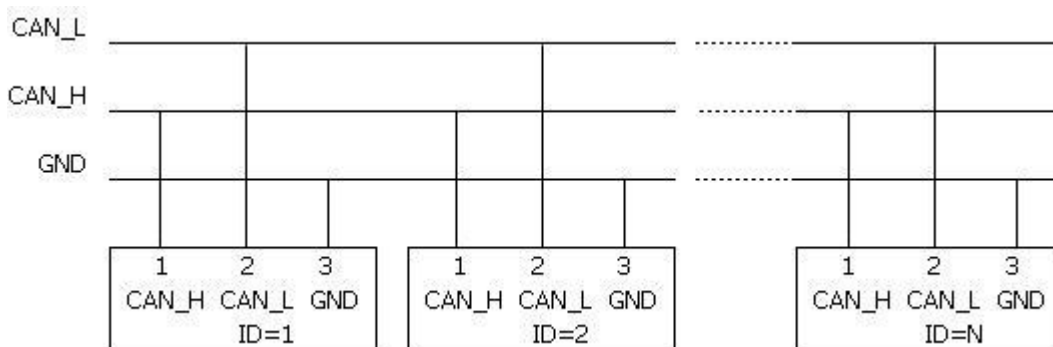

Figure 9-1 Several FM860 communication

It need to add a 120-150ohm resistor between CAN_L and CAN_H, and can set the DIP switch as SW9 to

connecting the resistor.

3. Set the communication parameters such as baud rate, ID address, default as 500K and 1 respectively. Need to save and reboot after updated.

4. You can follow CANopen communication protocol to set up FM Stepping Motor Drive. As for this example, is used the data formatting of CANopen communication protocol to operate FM drive for each mode.

Following figure is the example to send command to set 6040 as 3F. the lower part of the figure is send data, upper part of the figure is receive data.

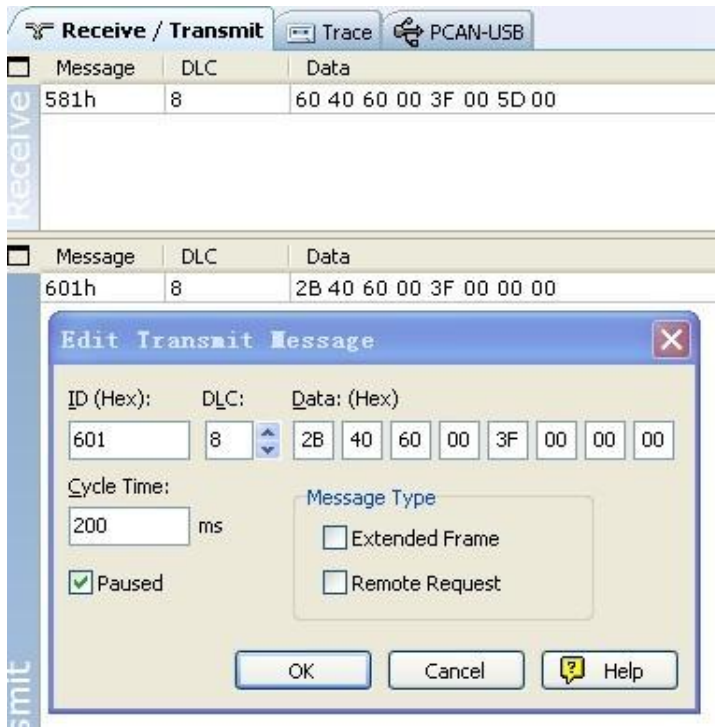

Table 9-1 Examples for sending and receiving message of Homing control mode with station number 1.

Homing control mode(the control word should change from F to 1F)				
CANopen address	Name	Setting Value	Send or Return message(ID=1)	Note
60600008	Operation mode	0x6	601 2F 60 60 00 06 00 581 60 60 60 00 06 00	Speed RPM have to Change as the unit of DEC. DEC=[(RPM*512*60000)/1875]
60980008	Homing mode	0x14	601 2F 98 60 00 14 00 581 60 98 60 00 14 00	
60990120	Turning signal speed of Homing	200RPM	601 23 99 60 01 00 00 32 00 581 60 99 60 01 00 00 32 00	
60990220	Homing signal speed	150RPM	601 23 99 60 02 00 80 25 00 581 60 99 60 02 00 80 25 00	
60400010	Control word	0xF	601 2B 40 60 00 F 00 581 60 40 60 00 F 00	
60400010	Control word	0x1F	601 2B 40 60 00 1F 00 581 60 40 60 00 1F 00	
601 40 41 60 00 00 00 00 00		Read status word, 9437means found homing		

Table 9-2 Examples for sending and receiving message of Position control mode with station number 1.

Position control mode(Absolute positioning of control word is changed from 2F to 3F, Relative positioning is changed from 4F to 5F 103F means activate immediately when position change)				
CANopen address	Name	Setting value	Message (ID=1)	Note
60400010	Control word	0xF	601 2B 40 60 00 0F 00 581 60 40 60 00 0F 00	Speed RPM need change to DEC. $DEC=[(RPM*512*60000)/1875]$ Both for Profile Acce and profile dece is defaulted as DEC. $DEC=[(RPS/S*65536*60000)/1000/4000]$
60600008	Operation mode	0x1	601 2F 60 60 00 01 00 581 60 60 60 00 01 00	
607A0020	Target-position	50000 DEC	601 23 7A 60 00 50 C3 00 00 581 60 7A 60 00 50 C3 00 00	
60810020	Profile velocity	200RPM	601 23 81 60 01 00 00 32 00 581 60 81 60 01 00 00 32 00	
60830020	Profile_Acce	10rps/s	Default value	
60840020	Profile_Dece	10rps/s	Default value	
60400010	Control word	0x2F	601 2B 40 60 00 2F 00 581 60 40 60 00 2F 00	
		0x3F(Absolute positioning)	601 2B 40 60 00 3F 00 581 60 40 60 00 3F 00	
		0x4F	601 2B 40 60 00 4F 00 581 60 40 60 00 4F 00	
		0x5F(Relative positioning)	601 2B 40 60 00 5F 00 581 60 40 60 00 5F 00	
601 40 41 60 00 00 00 00 0			Read status word, D437 means target position reach.	

Table 9-3 Examples for sending and receiving message of Speed control mode with station number 1.

Speed control mode				
CANopen address	Name	Setting value	Message (ID=1)	Note
60600008	Operation mode	0x3	601 2F 60 60 00 03 00 581 60 60 60 00 03 00	Speed RPM need change To DEC. $DEC=[(RPM*512*60000)/1875]$
60FF0020	Target speed	150RPM	601 23 FF 60 02 00 80 25 00 581 60 FF 60 02 00 80 25 00	

60400010	Control word	0xF	601 2B 40 60 00 0F 00 581 60 40 60 00 0F 00	DEC=[(RPS/S*65536*60000)/ 1000/4000]
60830020	Profile Acceleration	10rps/s	Default value	
60840020	Profile Deceleration	10rps/s	Default value	

Note: The transmission formatting of all data is following Hexadecimal in communication mode.

9.2 Appendix II RS485 Communication Case

9.2.1 Modbus Communication between FM860 and KINCO HMI

1. HMI control single FM Drive

a. Wiring diagram

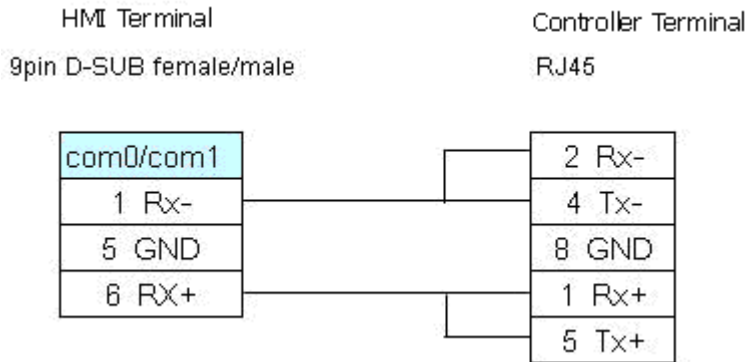

Figure 9-2 RS485 communication

b. Parameters setting

It need choose Modbus RTU in HMI software. The communication parameters are as following figure. The PLC station No. must be set same as the ID of FM drive.



Figure 9-3 communication parameters settings

c. Address setting

It need use address type 4X in HMI program (all the objects of FM are corresponding to 4X). According to Modbus address of objects in the Common Object List, the Modbus address of the object Target velocity(60FF0020 is 0x6F00, Its decimal value is 28416. when we use this address in HMI, we need to add 1, so in HMI the address for Target velocity is 28417 as following figure.

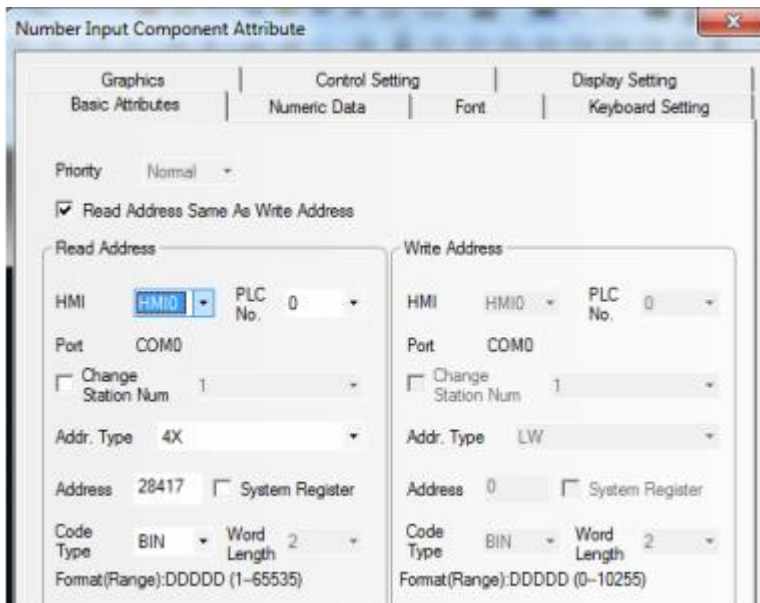

Figure 9-4 Address parameter settings

(2) HMI control multiple FM drive

a. Wiring diagram

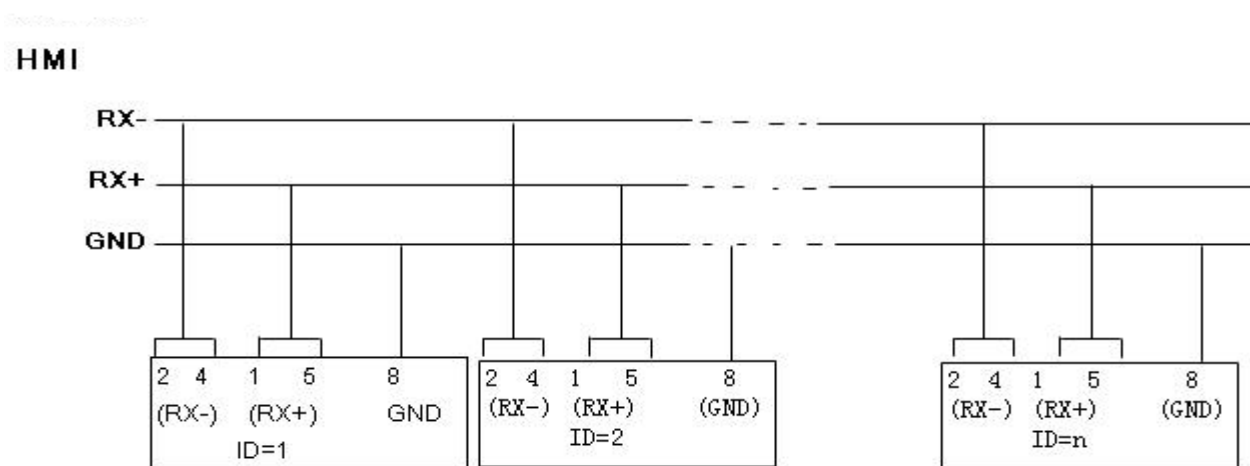

Figure 9-5 HMI communicate with several FM (1)

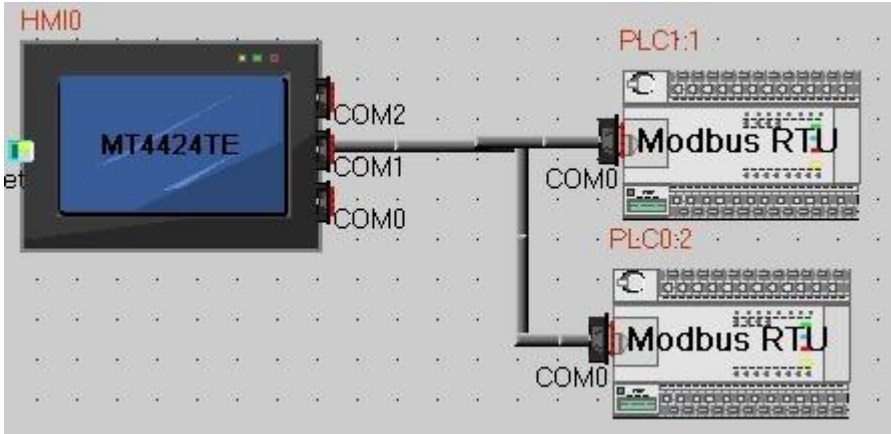

Figure 9-6 HMI communicate with several FM (2)

b. Parameters setting

The parameters setting in HMI is same as such example. The difference is different station number for different FM Drive. In the attribute of components of HMI. It needs to select the PLC No. for different FM drive. (The PLC No. is not the drive station No. as shown in the figure above. PLC0:2 means the PLC No. as 0, and station No. as 2)

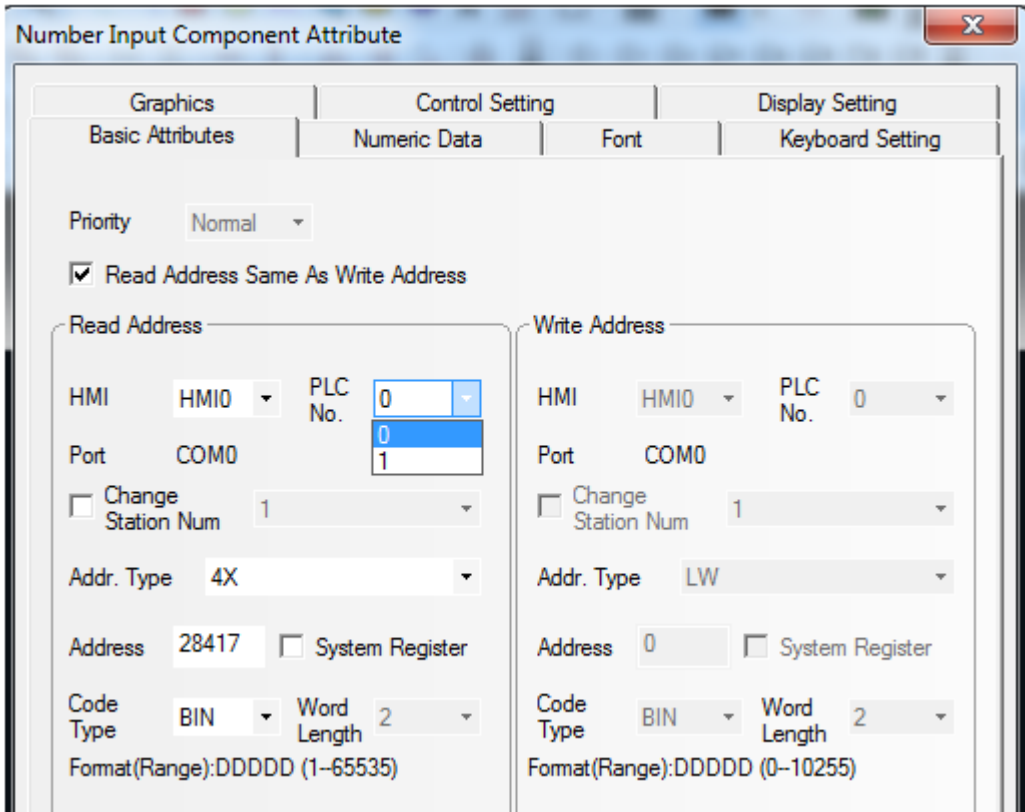

Figure 9-7 HMI parameters

9.2.2 Communication between FM860 and Modbus

1. Wiring diagram

PC has to use RS232-RS485 module to connect FM drive.

RS485 module terminal

FM860 RS485 (X1)

D- _____ 2\4(RX-, TX-)
 D+ _____ 1\5(RX+, TX+)
 GND _____ 8 (GND)

2. Please refer Serial protocol communication in Appendix III to set up ID address and baud rate, and defaulted as 19200 and 1. Need to save and reboot if updated.

3. Please follow Modbus RTU communication protocol to control FM860 after finished such steps.

As below figure read object 0x60400010 control words, need to add offset1.

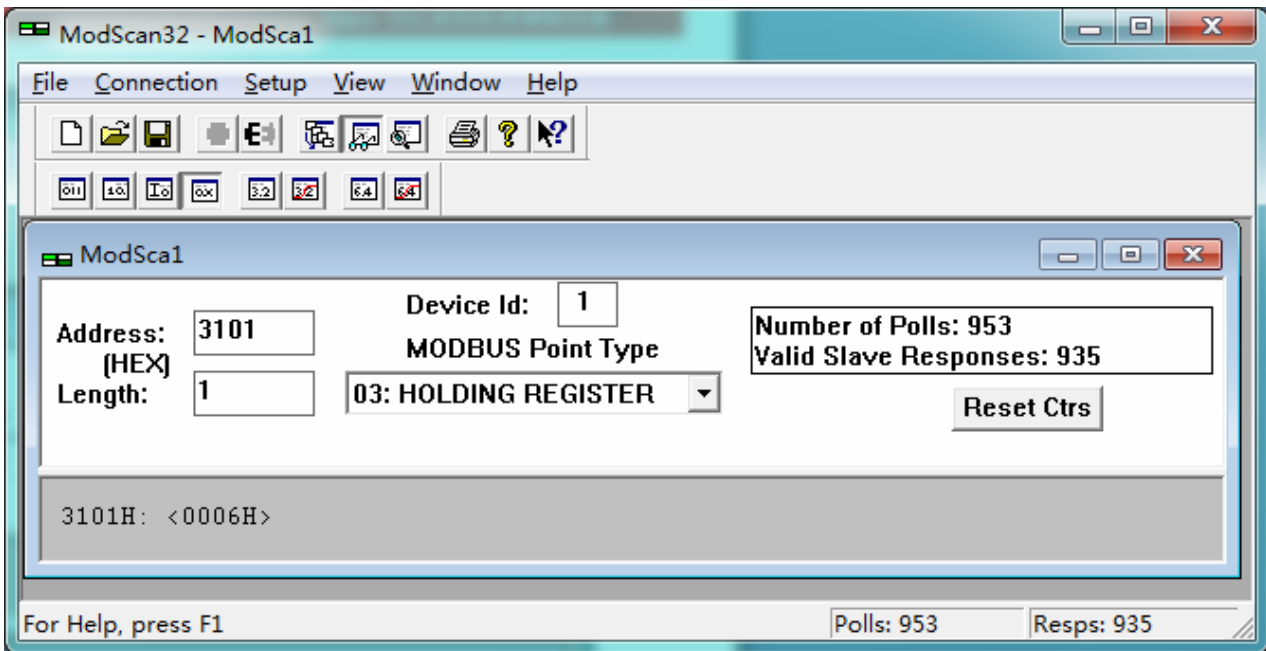

Figure 9-8 Modbus parameters

You can read object 0x60400010 by manual as below figure.

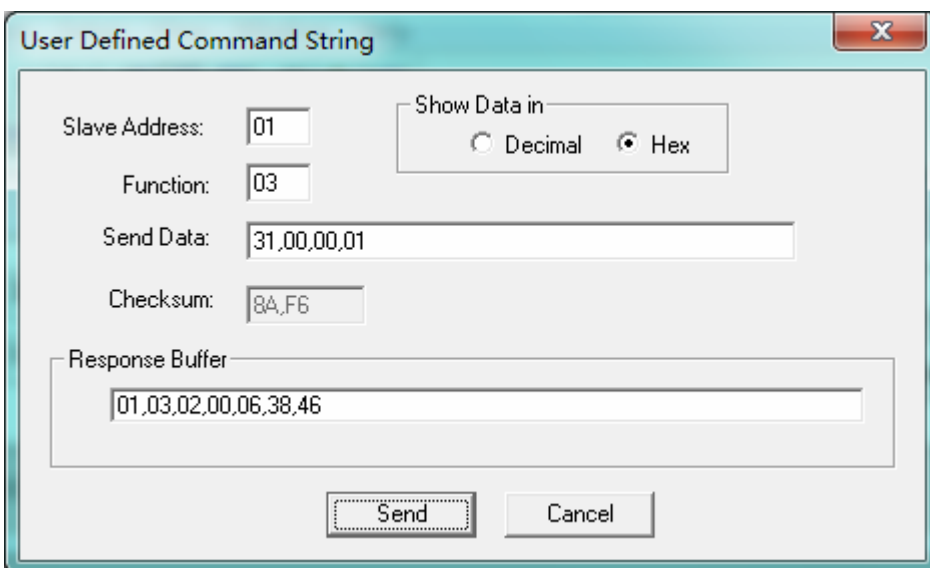

Figure 9-9 Read objects

All mode send message in status number 1.

Table 9-4 Examples for sending message of Homing and position control mode with station number 1

Homing control mode (control word is changed from F to 1F)
--

Modbus address	Name	Setting value	Send and return message (ID=1)	Note
0x3500	Operation mode	0x6	01 06 35 00 00 06 06 04 01 06 35 00 00 06 06 04	DEC=[(RPM*512*60000)/1875]
0x4D00	Homing mode	0x14	01 06 4D 00 00 14 9E A9 01 06 4D 00 00 14 9E A9	
0x5010	Turning signal speed of homing	200RPM	01 10 50 10 00 02 04 00 00 00 32 8F 75 01 10 50 10 00 02 51 0D	
0x5020	Homing signal speed	150RPM	01 10 50 20 00 02 04 80 00 00 25 E5 AF 01 10 50 20 00 02 51 02	
0x3100	Control word	0xF	01 06 31 00 00 0F C7 32 01 06 31 00 00 0F C7 32	
0x3100	Control word	0x1F	01 06 31 00 00 1F C6 FE 01 06 31 00 00 1F C6 FE	
01 03 32 00 00 01 8A B2			Read status word, 9437 means found homing	
Position control mode(Absolute positioning of control word is changed from 2F to 3F, Relative positioning is changed from 4F to 5F 103F means activate immediately when position change)				
Modbus address	Name	Setting value	Send and return message (ID=1)	Note
0x3100	Control word	6	01 06 31 00 00 06 07 34 01 06 31 00 00 06 07 34	DEC=[(RPM*512*60000)/1875]
0x3500	Operation mode	1	01 06 35 00 00 01 47 C6 01 06 35 00 00 01 47 C6	
0x4000	Target-position	50000 DEC	01 10 40 00 00 02 04 C3 50 00 00 FE 39 01 10 40 00 00 02 54 08	
0x4A00	Profile-Speed	200RPM	01 10 4A 00 00 02 04 00 00 00 32 3D 19 01 10 4A 00 00 02 57 D0	
0x4B00	Profile_Acce	10rps/s	Default value	
0x4C00	Profile_Dece	10rps/s	Default value	
0x3100	Control word	2F	01 06 31 00 00 2F C6 EA 01 06 31 00 00 2F C6 EA	
		3F(Absolute positioning)	01 06 31 00 00 3F C7 26 01 06 31 00 00 3F C7 26	
		4F	01 06 31 00 00 4F C6 C2 01 06 31 00 00 4F C6 C2	
		5F(Relative positioning)	01 06 31 00 00 5F C7 0E 01 06 31 00 00 5F C7 0E	

Table 9-5 Examples for sending message of Speed control mode with station number 1

Speed control mode				
Modbus address	Name	Setting value	Message (ID=1)	Note
0x3500	Operation mode	3	01 06 35 00 00 03 C6 07 01 06 35 00 00 03 C6 07	DEC=[(RPM*512*60000)/1875] DEC=[(RPS/S*65536*60000)/1000/4000]
0x6F00	Target-speed	150RPM	01 10 6F 00 00 02 04 80 00 00 25 F2 46 01 10 6F 00 00 02 5C DC	
0x4B00	Profile_Acce	10rps/s	Default value	
0x4C00	Profile_Dece	10rps/s	Default value	
0x3100	Control word	F	01 06 31 00 00 0F C7 32 01 06 31 00 00 0F C7 32	

Note: All the data are hexadecimal formatting when using communication.

9.2.3 Modbus Communication Between FM860 and Siemens S7-200

1. Wiring diagram

Signal connecting is as below.

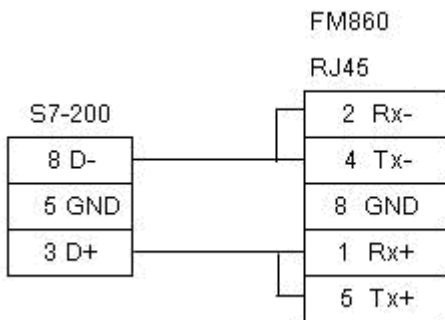

Figure 9-10 RS485 communication

2. Parameters setting

As for the parameter setting of FM Stepping motor drive, please refer to Chapter?? The default parameters are Modbus RTU. 19200, none check code.

In the software of S7-200 PLC, there is a library function used to set communication parameters as shown in following figure.



Figure 9-11 S7-200 PLC communication parameters

3. Program

It use Modbus function (MODBUS_MSG) to send and receive data. The descriptions of Modbus function are shown in following figure.

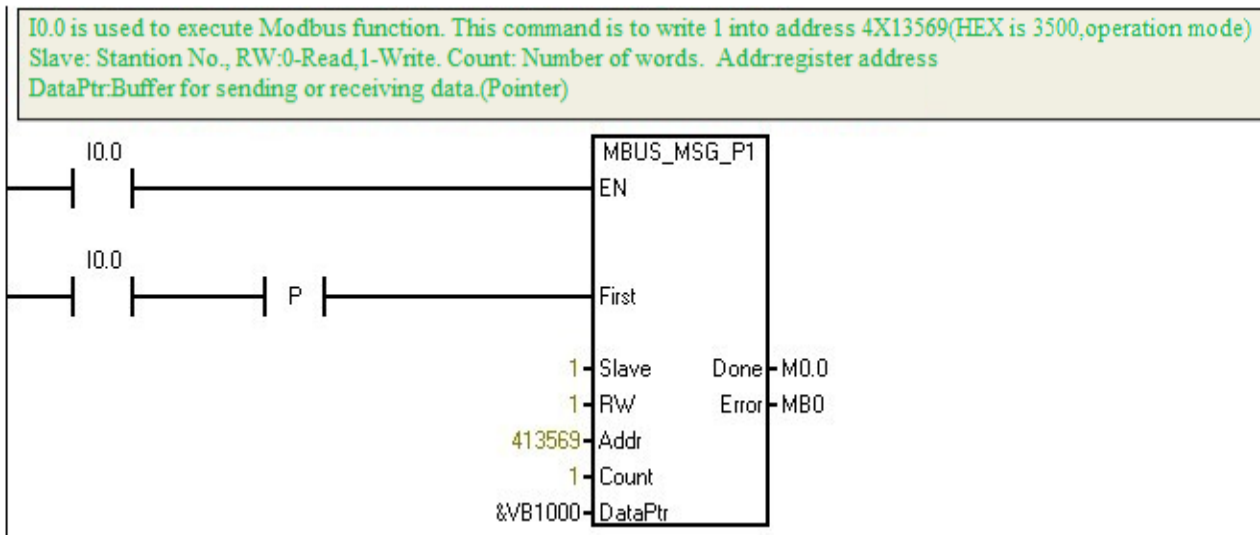

Figure 9-12 Modbus function definition

4. Example descriptions

Table 9-6 Case for program

S7200 PLC input port	Function	Explanation
I0.0	Write 60600008=1	Set position mode
I0.1	Write 607A0020=10000	Set the target position
I0.2	Write 60810020=1000rpm	Set the profile velocity
I0.3	Write 60400010=0x4F 后 0x5F	Control command = relative motion
I0.4	Read 60630020	Read motor position
I0.5	Read 60410010	Read driver status word

9.3 Appendix III RS232 Communication Case

9.3.1 Communication between FM860 and KINCO HMI

Kinco MT4000 and MT5000 series HMI can communicate with FM drive via RS232. User can set internal parameters of FM drive and running status of FM drive. Kinco HMI can communicate with single FM drive. And communicate with multiple FM drives via RS232.

HMI control single FM drive

Wiring diagram

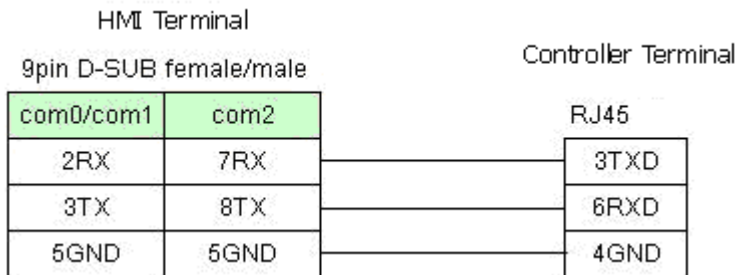

Figure 9-13 RS232 Communication

b. Communication parameters setting

The parameter setting is shown as following picture. Pay attention to PLC station number is the Drive ID number. The drive ID number is defaulted as 1. if you want to set up it as N, PLC station number also is N.

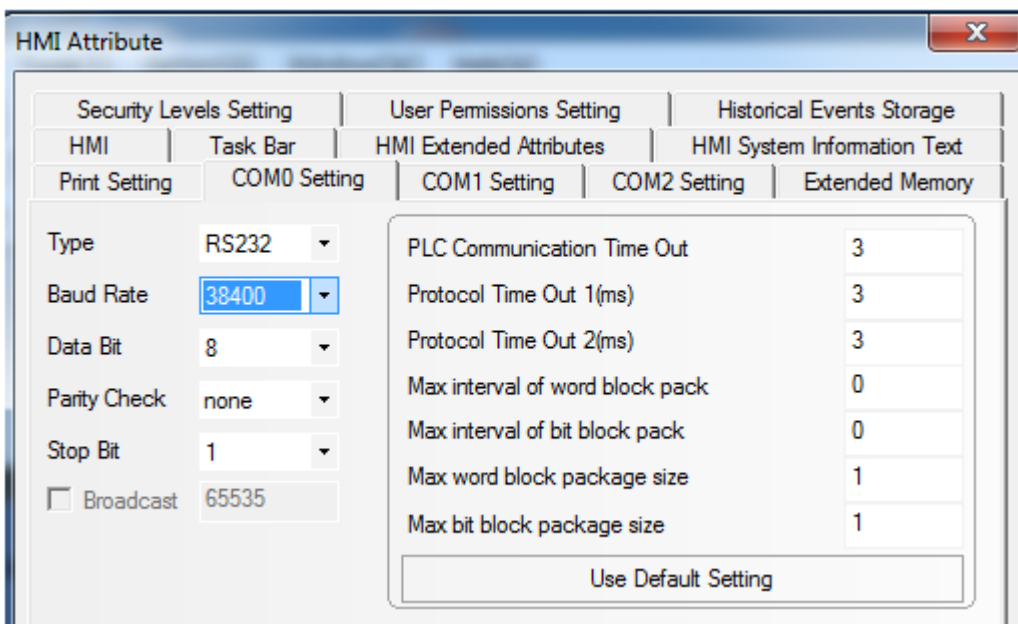

Figure 9-14 communication parameters settings (1)

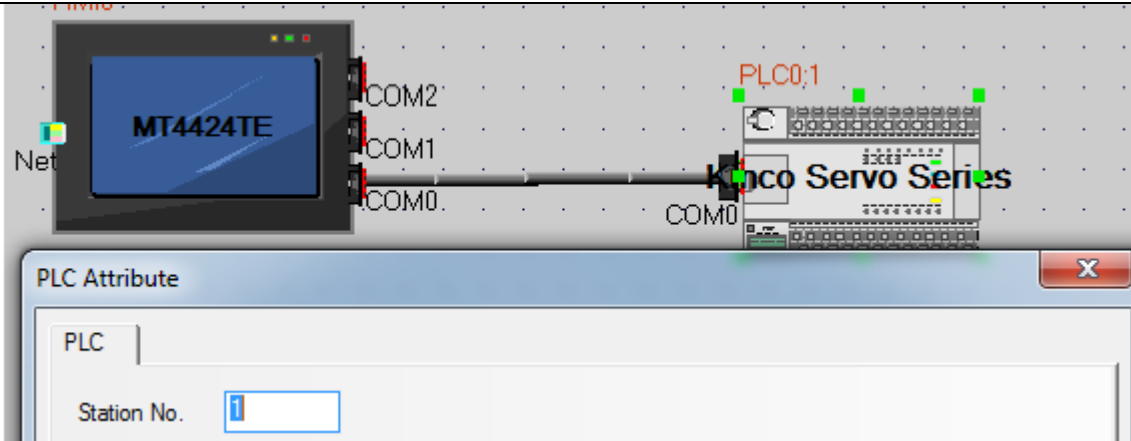

Figure 9-15 communication parameters settings (2)

c. Address Setting

At the first, we have to set up the data length of object as below picture to write HMI program. The address types are 08(8bits), 10(16bits) and 20(32 bits). The formatting of address is Index, Sub-index, following figure is an example for using object 60FF0020(target-speed)

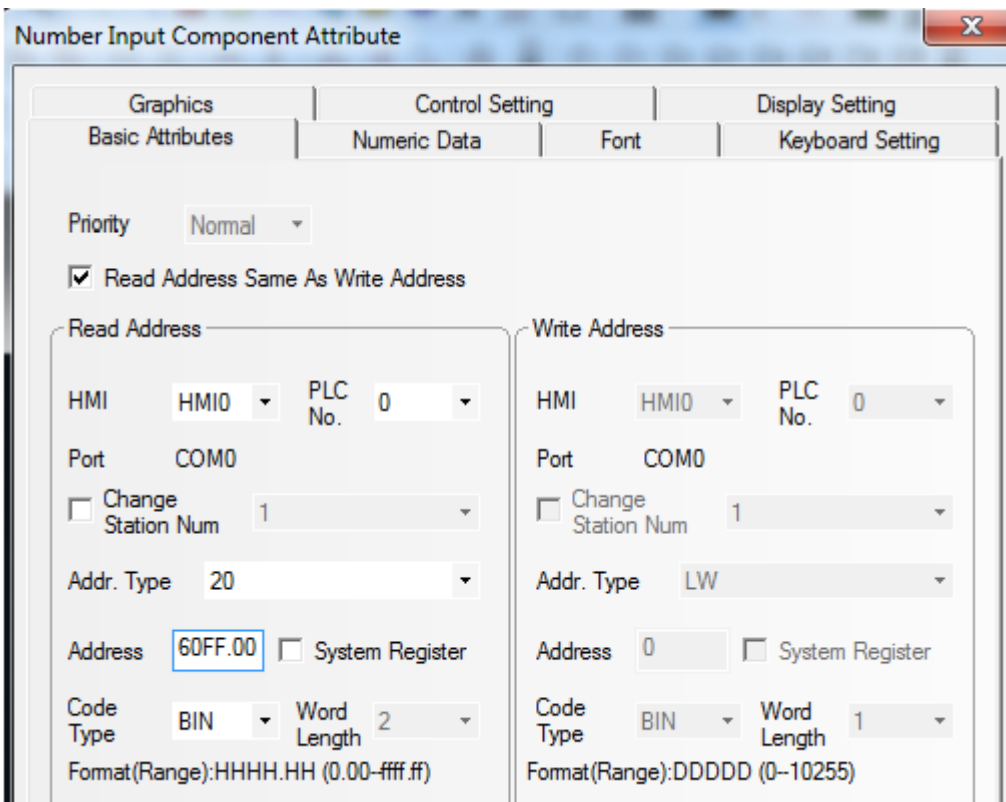

Figure 9-16 Address settings

9.3.2 The Free Protocol Communication between FM860 and Adjustment tool of Serial port

RS232 communication protocol of FM drive is customized. User can control the drive by VB and VC.

Following is the case for your reference.

1. Wiring diagram

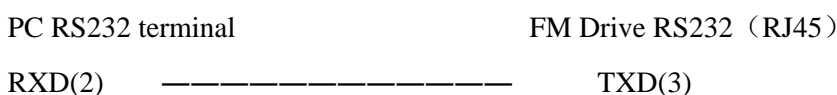

TXD(3) ----- RXD(6)
 GND(5) ----- GND(4)

2. Please refer series communication to set up ID address and baudrate as station number 1 and 38400. Need to save and reboot it after updated.3. Then find RS232 free communication protocol to control FM drive after finish such step. Following are different mode to send message, all station ID is 1.

3. At present, please refer RS232 communication protocol as chapter 7 to control FM stepping motor driver. For example as bellowing, send 6040 as 3F, the data in blue is sent, and is returned message in green frame. Red parts are communication parameters.



图 9-17 Serial debugging assistant settings

Table 9-7 Example for sending message of Homing and position control mode with station number 1

Homing Control Mode(Write control word F first then 1F)				
Canopen address	Name	Setting value	Send and return message (ID=1)	Note
60400010	Control word	0xF	01 2B 40 60 00 0F 00 00 00 25 01 60 40 60 00 0F 00 00 00 F0	DEC DEC=[(RPM*512 *60000)/1875]
60600008	Operation mode	0x6	01 2F 60 60 00 06 00 00 00 0A 01 60 60 60 00 06 00 00 00 D9	
60980008	Homing mode	0x23	01 2F 98 60 00 23 00 00 00 B5 01 60 98 60 00 23 00 00 00 84	
60990120	Signal speed Of homing turning	200RPM	01 23 99 60 01 00 00 32 00 30 01 60 99 60 01 00 00 32 00 73	
60990220	Speed of	150RPM	01 23 99 60 02 00 80 25 00 3C	

	homing signal		01 60 99 60 02 00 80 25 00 FF	
60400010	Control word	0x1F	01 2B 40 60 00 1F 00 00 00 15 01 60 40 60 00 1F 00 00 00 E0	
01 40 41 60 00 00 00 00 00 1E Read status word, 9437 means found homing				
Position Control Mode(control word of absolute positioning is written 2F then 3F, relative positioning is written 4F then 5F, 103F update immediately)				
Canopen address	Name	Setting value	Send and return message (ID=1)	Note
60400010	Control word	0xF	01 2B 40 60 00 0F 00 00 00 25 01 60 40 60 00 0F 00 00 00 F0	DEC=[(RPM*512*60000)/1875]
60600008	Operation mode	0x1	01 2F 60 60 00 01 00 00 00 0F 01 60 60 60 00 01 00 00 00 DE	
607A0020	Target position	50000 DEC	01 23 7A 60 00 50 C3 00 00 EF 01 60 7A 60 00 50 C3 00 00 B2	
60810020	Profile_Speed	200RPM	01 23 81 60 00 00 00 32 00 C9 01 60 81 60 00 00 00 32 00 8C	
60830020	Profile_Acce	10rps/s	Default value	
60840020	Profile_Dece	10rps/s	Default value	
60400010	Control word	0x2F	01 2B 40 60 00 2F 00 00 00 05 01 60 40 60 00 2F 00 00 00 D0	
		0x3F(absolute positioning)	01 2B 40 60 00 3F 00 00 00 F5 01 60 40 60 00 3F 00 00 00 C0	
		0x4F	01 2B 40 60 00 4F 00 00 00 E5 01 60 40 60 00 4F 00 00 00 B0	
		0x5F(relative positionning)	01 2B 40 60 00 5F 00 00 00 D5 01 60 40 60 00 5F 00 00 00 A0	

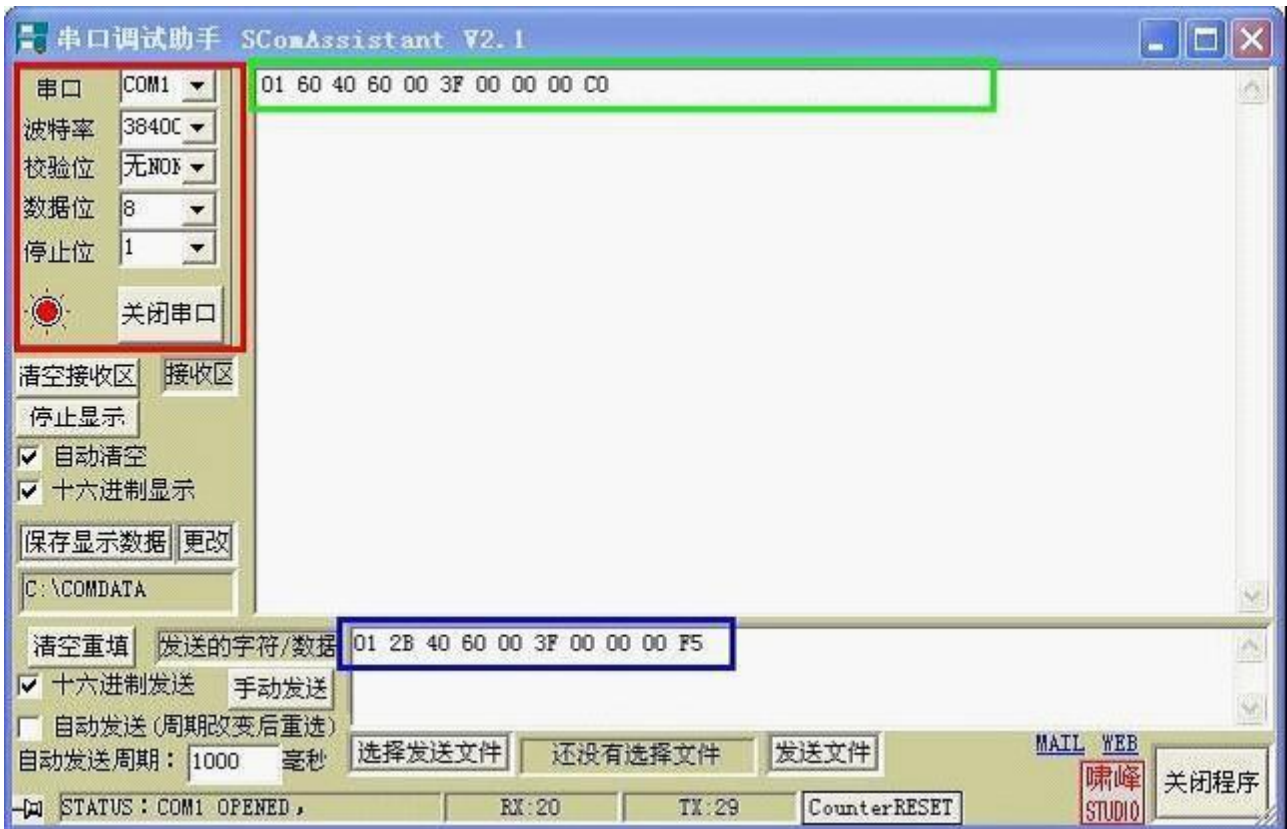
Table 9-8 Examples for sending message of Speed control mode with station number 1

Speed Control Mode				
Canopen address	Name	Setting value	Message (ID=1)	Note
60600008	Operation mode	0x3	01 2F 60 60 00 03 00 00 00 0D 01 60 60 60 00 03 00 00 00 DC	DEC=[(RPM*512*60000)/1875]
60FF0020	Target-speed	150RPM	01 23 FF 60 00 00 80 25 00 D8 01 60 FF 60 00 00 80 25 00 9B	
60830020	Profile_Acce	10rps/s	Default value	DEC=[(RPS/S*65536*60000)/1000/4000]
60840020	Profile_Dece	10rps/s	Default value	

60400010	Control word	0xF	01 2B 40 60 00 0F 00 00 00 25 01 60 40 60 00 0F 00 00 00 F0
----------	--------------	-----	--

Note: All the data are hexadecimal formatting when using communication mode.

9.3.3 Console wire

Console wire is the patch cord from Drive to PC, the end terminal is RS232 as DB9 port, others end is RJ45 port. The picture is as below.



Figure 9-18 RS232 Patch cord (1)

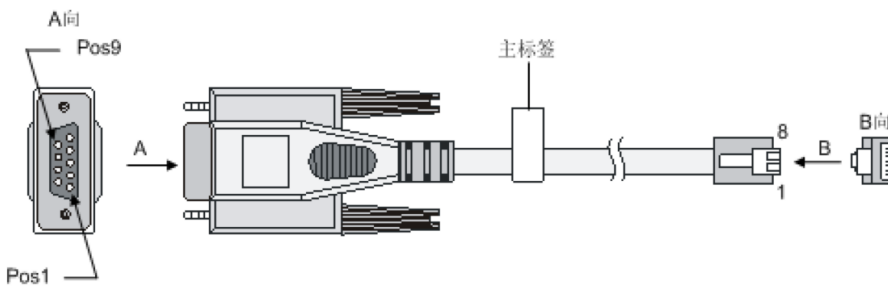

Figure 9-19 RS232 Patch code (2)

The connecting of the pins of wire is as bellows:

- DB9 port (female)-----RJ45 port
- RXD (2) ----- TXD (3)
- TXD (3) ----- RXD (6)
- DTR (4) ----- DSR (7)
- GND (5) ----- GND (4)&(5)
- DSR (6) ----- DTR (2)
- RTS (7) ----- CTS (8)
- CTS (8) ----- RTS (1)

9.4 Appendix IV Homing Method

The homing of FM drive is following the definition as DSP402 of CANopen. Support the homing mode from 17 to 30 and 35.

Mode 17: Defined the homing signal as Negative limit, the running line is as belows.

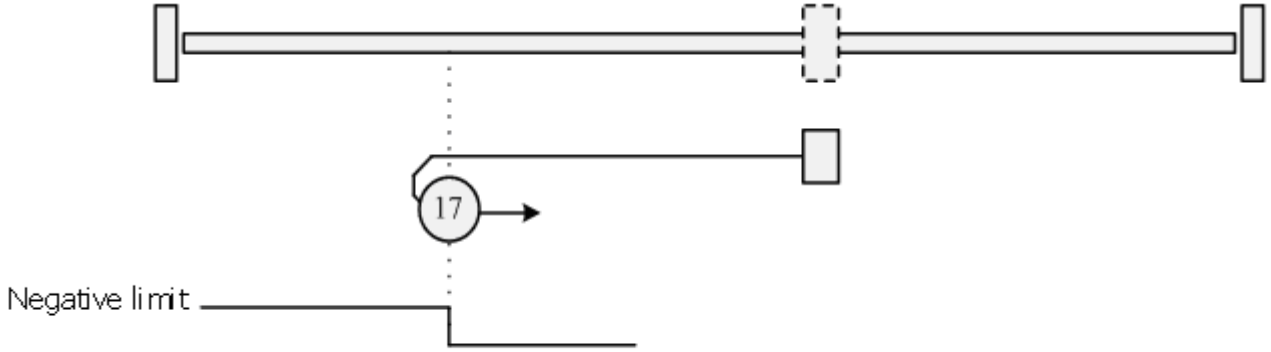

Figure 9-20 Homing 17

Mode 18: Defined Positive limit to be the homing signal, the running line is as bellows.

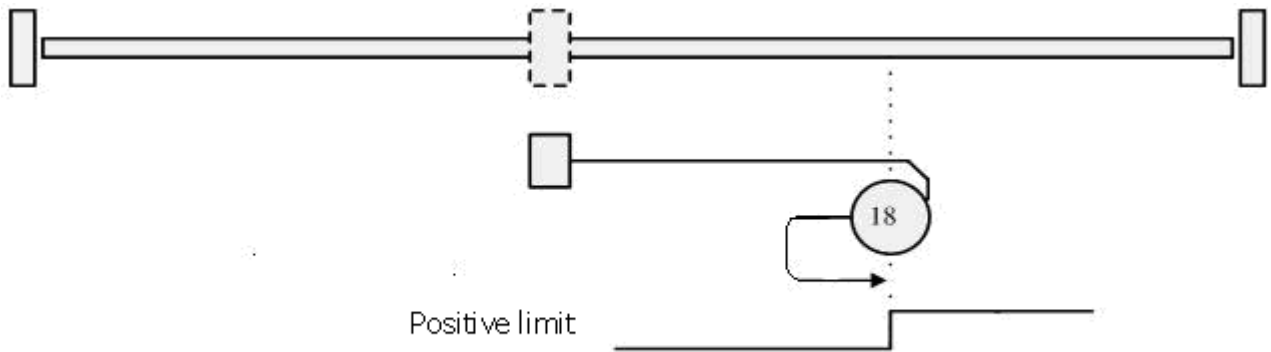

Figure 9-21 Homing 18

Homing Mode 19 and 20: Defined the external homing switch is the homing trigger signal, the Initial movement direction is positive, following is the running line.

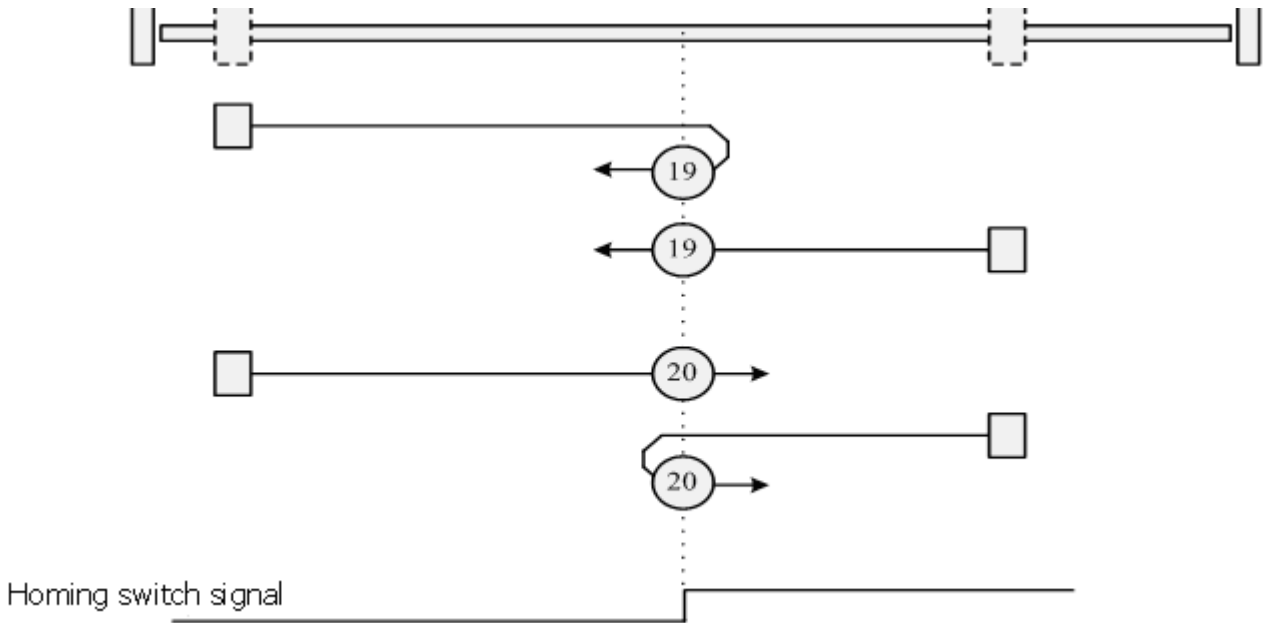

Figure 9-22 Homing 19 and 20

Homing mode 21-22: Defined the external homing switch is the homing trigger signal. The initial movement direction is Negative. Following is the running line.

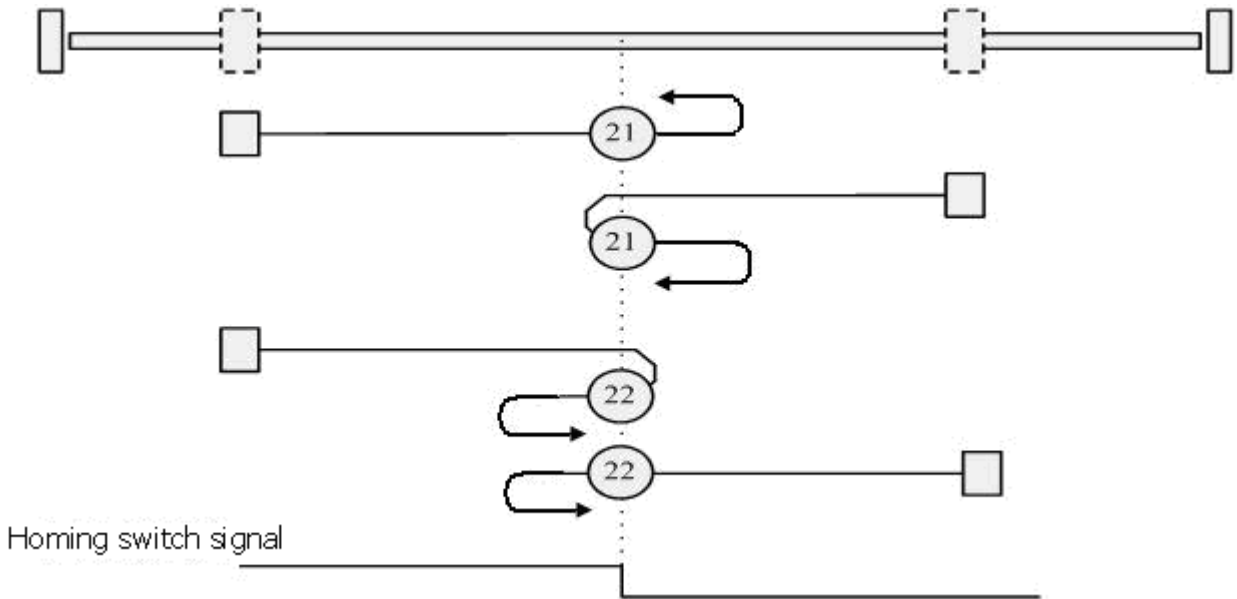

Figure 9-23 Homing 21 and 22

Mode 23-26: With double limit, defined the external homing switch is the trigger signal, the initial direction is positive, following is the running line.

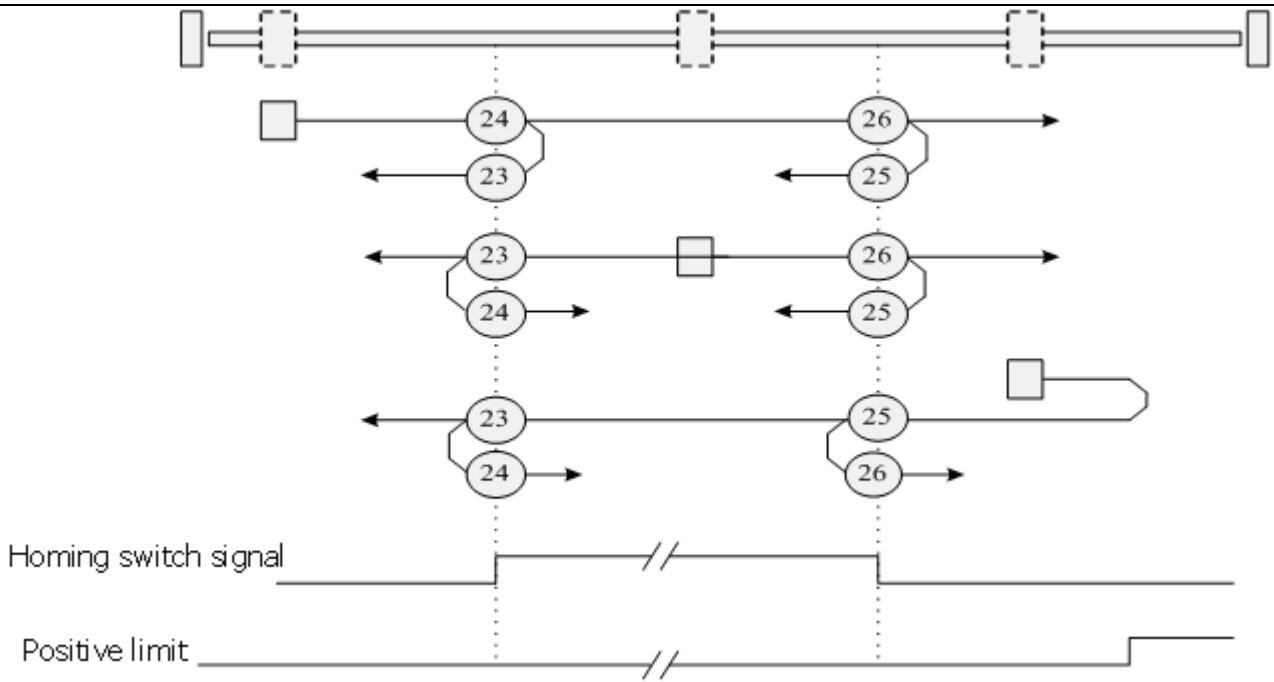

Figure 9-24 Homing from 23 to 26

Homing Mode 27-30: With double limit, defined the external homing switch is the trigger signal, the initial direction is negative, following is the running line.

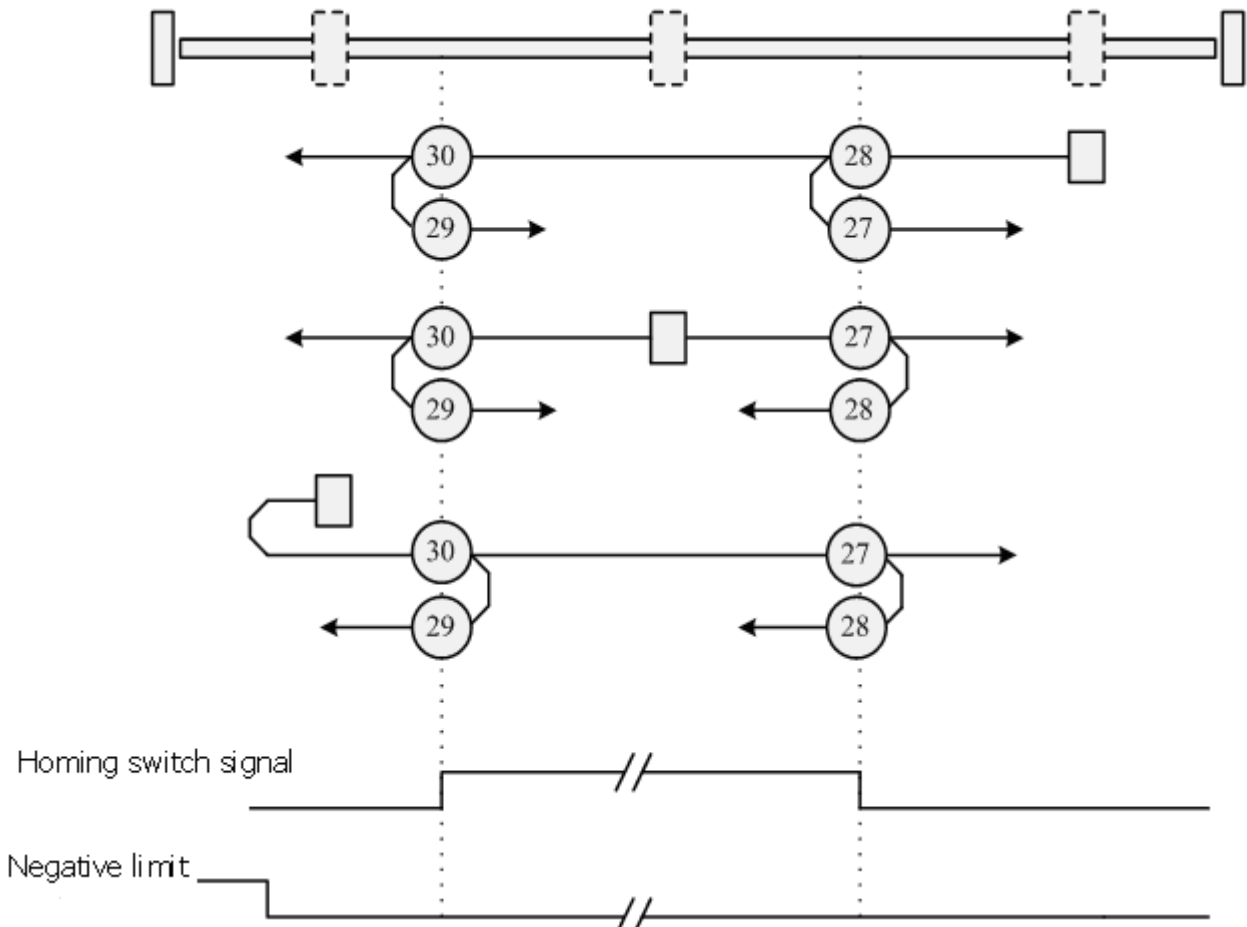

Figure 9-25 Homing from 27 to 30

Homing Mode 35: The current position of Motor is to be the homing.

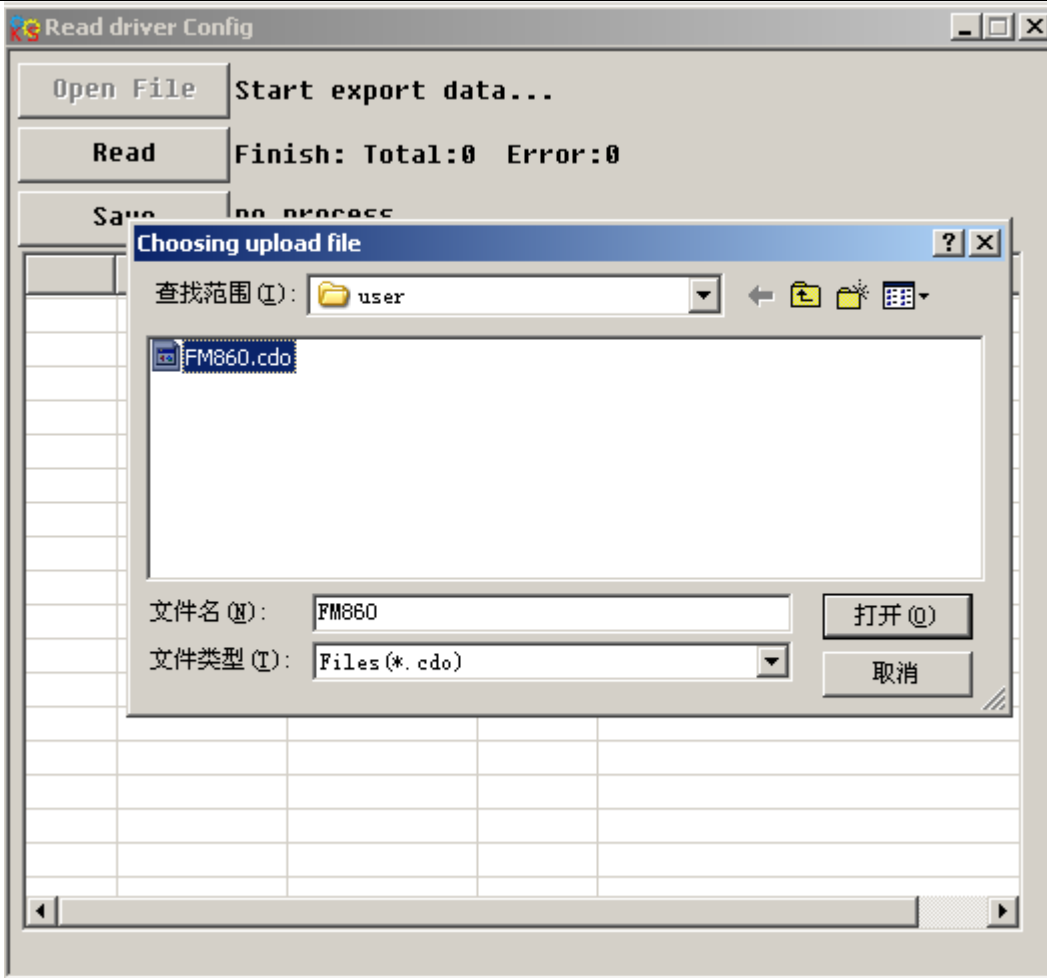

Figure 9-27 Read drive (2)

3. Click Read, then column of value will be read and shown as bellows.

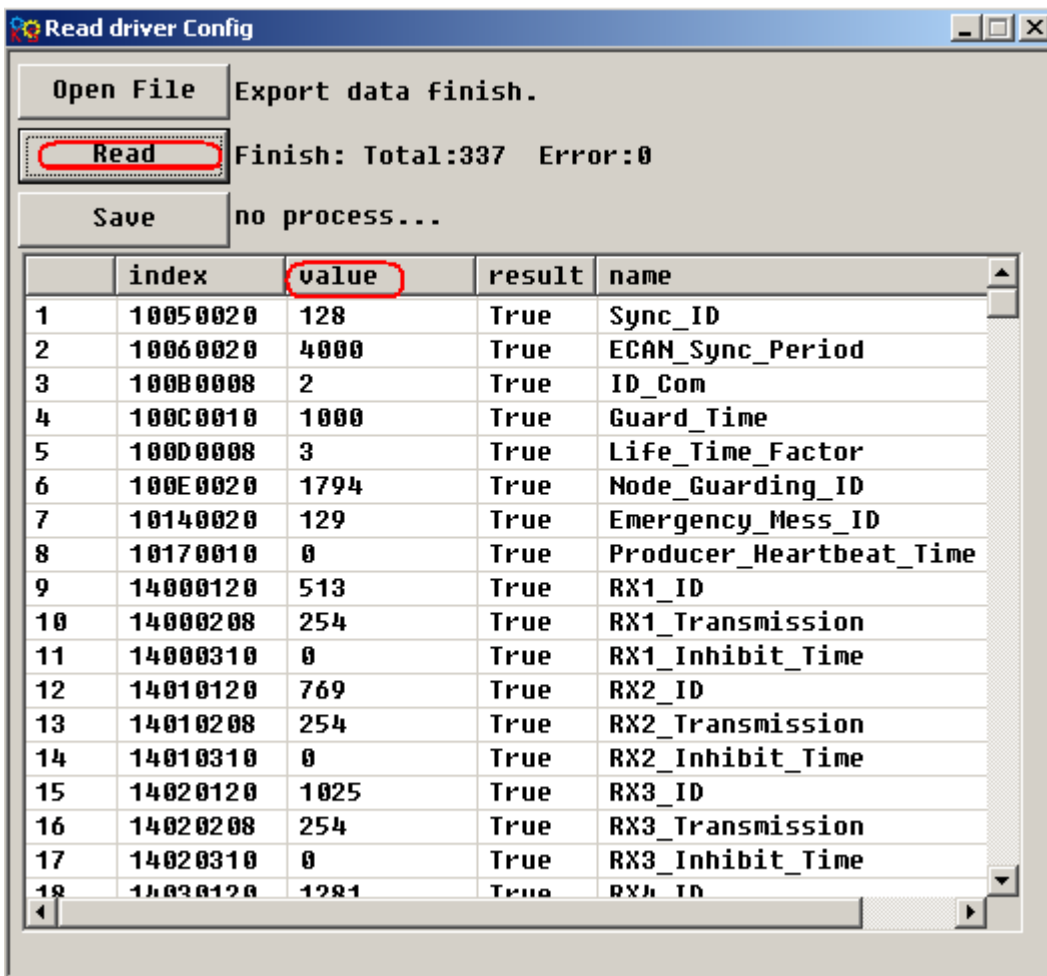

Figure 9-28 Read drive (3)

4. Click Save button, make the data to be saved on the default position. Now you finished the operation.
5. If you want to use the data which you just saved to a new drive, then you can click Write Drive Configuration in the Extend list and select Open file button to find your data.

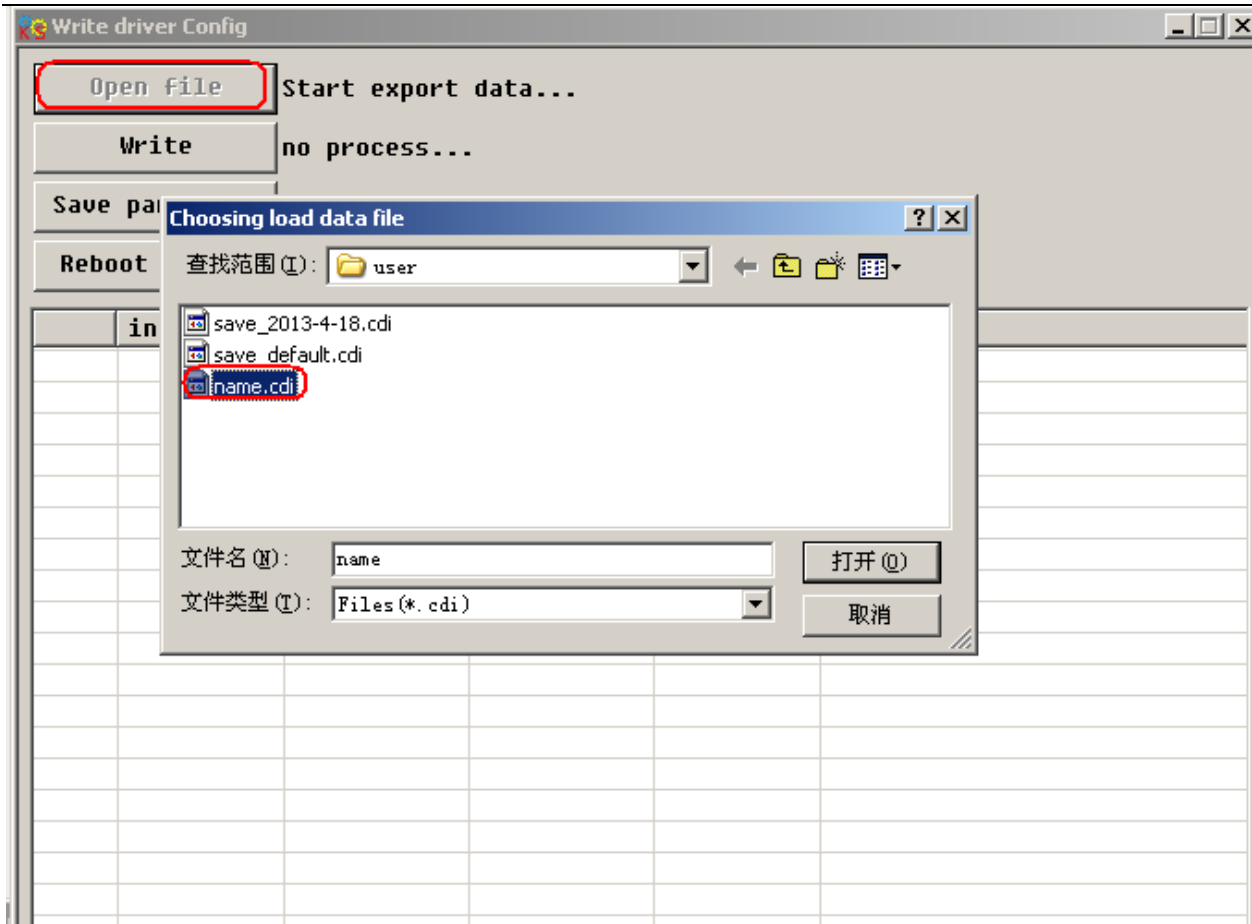

Figure 9-29 Write drive (1)

6. Click Write data, the data you saved will be updated to the drive, will be show True on result column. It means updated OK.

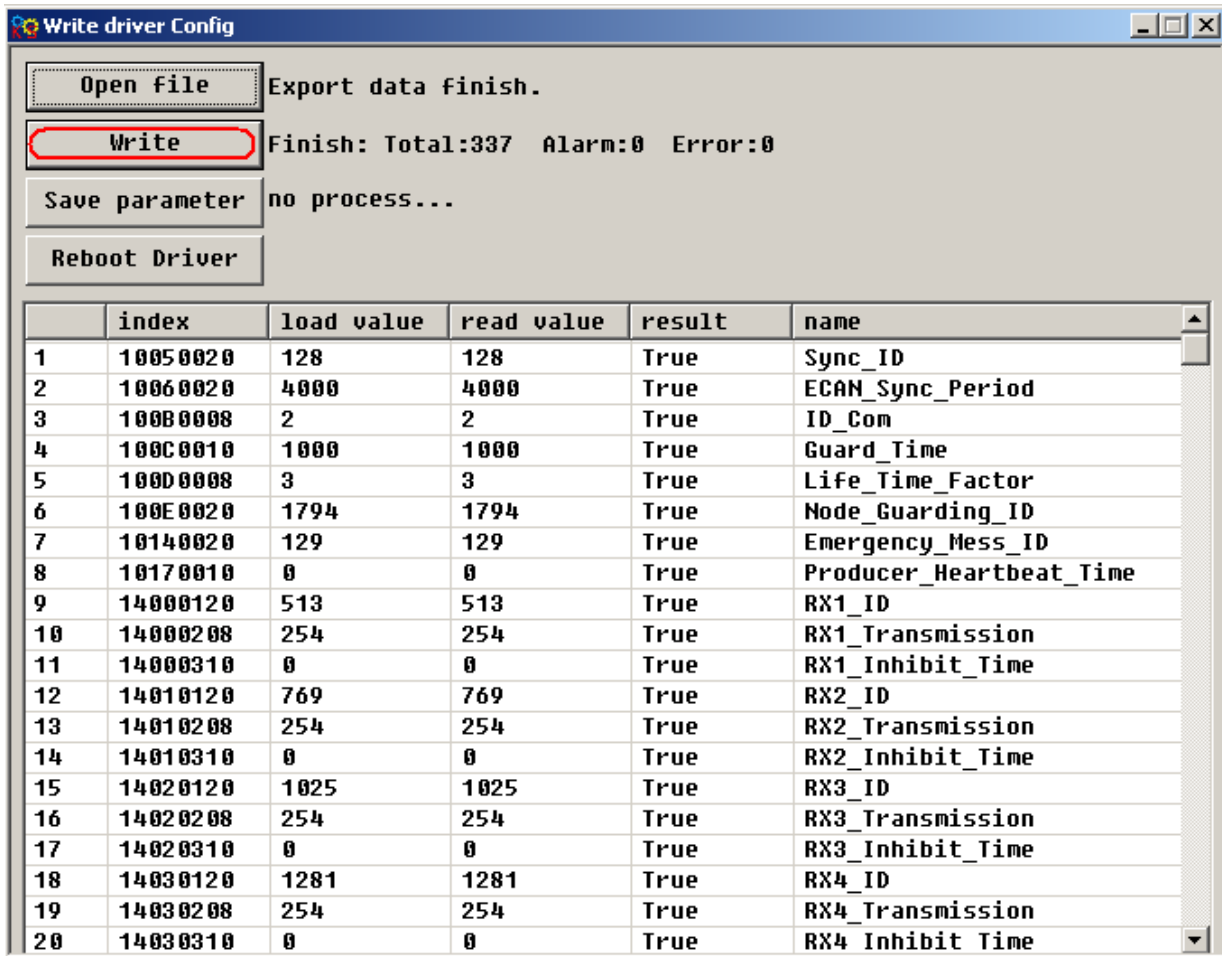

Figure 9-30 Write drive (2)

7. Click Save button, the parameters will be saved to drive. Then will show you Finish.

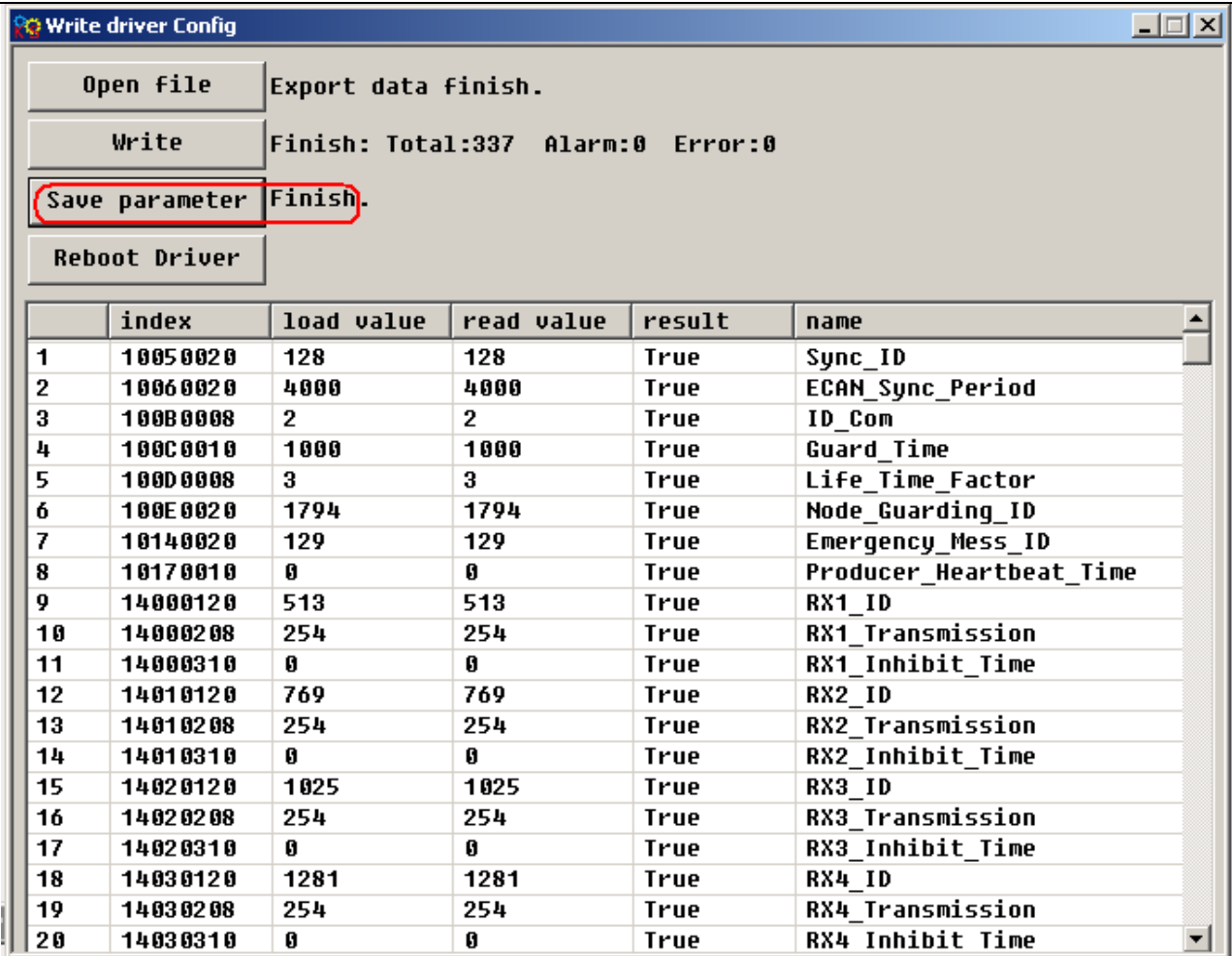

Figure 9-31 Write drive (3)

9.6 Appendix VI Conversion between Engineering unit and internal unit of Common objects

There are engineering unit and internal unit for some internal object in FM drive. When drive is controlled by communication, some objects use internal unit, therefore it needs to convert the unit. For example, the engineering unit for speed is RPM, and the internal unit is DEC. their conversion relationship is 1RPM=1638DEC. suppose to set speed as 10PRM, Then you need to send data 163840dec (The number of internal revolution as 60000 DEC) to the drive when using communication control

Table 9-9 List of common conversion unit

Parameter Name	Engineering unit	Internal unit	Conversion relationship
Speed	RPM	DEC	$DEC=[(RPM*512*60000)/1875]$
Acceleration	r/s*s	DEC	$DEC=[(RPS/S*65536*60000)/4000000]$
The number of pulses per revolution (Microstep)	step/rev	DEC	1rev=60000DEC, if 400tep equal to 1rev, so 1step equal to 60000/400=150DEC

9.7 Appendix VII Common Object List

Based on Chapter 7 Communication protocol described, all parameter value are transferred in hexadecimal data. In the later section of this document, we adopt the hexadecimal system and use index (16-bit index) and Sub-index (8-bit sub-index) to represent the register addressing. The digit 08 indicates the register will store data up to 1 byte, and the digit 10 indicates that the register will store data up to 2 bytes, and the digit 20 indicates the register will store data up to 4 bytes. It also covers the storage digits and read/write property of the register, read or write flag(RW), read-only or write-only flag(RO, WO) and mapping flag(M).

Table 9-10 mode and control

Canopen address	Bits	Modbus address	Command type	Unit	Descriptions
6040+00	10	0x3100	RW	Bit	Use control word to change status of drive=>machine state 0x06 Motor power-off 0x0F Motor power-on 0x0B Quick stop, load stop-voltage switched off 0x2F-3F Start absolute positioning immediately 0x4F-5F Start relative positioning 0x103F start absolute positioning mode according to target-position changes 0x0F-1F Start Homing

					0X80 Clear internal error
6041+00	10	0x3200	RO	Bit	Status byte shows the status of drive bit0: ready to switch on) bit1: switch on bit2: operation enable) bit3: fault bit4: Voltage Disable bit5: Quick Stop bit6: switch on disable bit7: warning bit8: Internal reserved bit9: Reserved bit10: Target reach bit11: Internal limit active bit12: Step.Ach./V=0/Hom.att. bit13: Foll.Err/Res.Hom.Err. bit14: Commutation Found bit15: Reference Found
6060+00	08	0x3500	RW	DEC	Operation mode: 1---Position 3---Speed -4---Pulse 6---Return to homing
6061+00	08	0x3600	RO	DEC	Valid operation mode

Table 9-11 Measurement data

Canopen address	Bits	Modbus address	Command type	Unit	Description
6063+00	20	0x3700	RO	DEC	Real position value
606C+00	10	0x3B00	RO	DEC=[(RPM*512*60000)/1875]	Real velocity (rpm) Internal sampling time as 200mS
6078+00	10	0x3E00	RO	DEC 1Arms=1.414 Ap 1Arms=79dec	Real current value
60FD+00	20	0x6D00	RO	Bit	Input status bit0: Negative limit signal status bit1: Positive limit signal status bit2: Homing signal status
6078+00	10	0x3E00	RO	number	Real current value

6079+00	10	0x3F00	RO	V	The actual bus voltage
---------	----	--------	----	---	------------------------

Table 9-12 Target object

Canopen address	Bits	Modbus address	Command type	Unit	Description
607A+00	20	0x4000	RW	DEC	Target position in operation mode 1, shift demand position if control word starts motion.
6081+00	20	0x4A00	RW	$DEC=[(RPM*512*60000)/1875]$	Max. velocity of trapezium profile in mode1.
6083+00	20	0x4B00	RW	$DEC=[(RPS/S*65536*60000)/4000000]$	Acceleration of the trapezium profile Default value:10rps/s
6084+00	20	0x4C00	RW		Profile_Dece Default value:10rps/s
60FF+00	20	0x6F00	RW	$DEC=[(RPM*512*60000)/1875]$	Target speed in mode 3
6071+00	10	0x3C00	RO	$1A_p=1.414A_{rms}$	Target-current
6073+00	10	0x3D00	RW	$1 A_{rms} =79dec$	Target current limit
6080+00	10	0x4900	RW	RPM	Max. speed limit

Table 9-13 Multiple-position, multiple-speed ($DEC=[(RPM*512*60000)/1875]$)

Canopen address	Bits	Modbus address	Command type	Unit	Description
2020+01	20	0x0C10	RW	DEC	Multiple position control 0
2020+02	20	0x0C20	RW	DEC	Multiple position control 1
2020+03	20	0x0C30	RW	DEC	Multiple position control 2
2020+04	20	0x0C40	RW	DEC	Multiple position control 3
2020+05	20	0x0C50	RW	DEC	Multiple position control 4
2020+06	20	0x0C60	RW	DEC	Multiple position control 5
2020+07	20	0x0C70	RW	DEC	Multiple position control 6
2020+08	20	0x0C80	RW	DEC	Multiple position control 7
2020+09	20	0x0C90	RW	DEC	Multiple position control 8
2020+0A	20	0x0CA0	RW	DEC	Multiple position control 9
2020+0B	20	0x0CB0	RW	DEC	Multiple position control 10
2020+0C	20	0x0CC0	RW	DEC	Multiple position control 11

2020+0D	20	0x0CD0	RW	DEC	Multiple position control 12
2020+0E	20	0x0CE0	RW	DEC	Multiple position control 13
2020+0F	20	0x0CF0	RW	DEC	Multiple position control 14
2020+10	20	0x0D00	RW	DEC	Multiple position control 15
2020+11	20	0x0D10	RW	DEC	Multiple position control 0
2020+12	20	0x0D20	RW	DEC	Multiple speed control 1
2020+13	20	0x0D30	RW	DEC	Multiple speed control 2
2020+14	20	0x0D40	RW	DEC	Multiple speed control 3
2020+15	20	0x0D50	RW	DEC	Multiple speed control 4
2020+16	20	0x0D60	RW	DEC	Multiple speed control 5
2020+17	20	0x0D70	RW	DEC	Multiple speed control 6
2020+18	20	0x0D80	RW	DEC	Multiple speed control 7
2020+19	20	0x0D90	RW	DEC	Multiple speed control 8
2020+1A	20	0x0DA0	RW	DEC	Multiple speed control 9
2020+1B	20	0x0DB0	RW	DEC	Multiple speed control 10
2020+1C	20	0x0DC0	RW	DEC	Multiple speed control 11
2020+1D	20	0x0DD0	RW	DEC	Multiple speed control 12
2020+1E	20	0x0DE0	RW	DEC	Multiple speed control 13
2020+1F	20	0x0DF0	RW	DEC	Multiple speed control 14
2020+20	20	0x0E00	RW	DEC	Multiple speed control 15
2020+36	08	0x0F60	RW	DEC	Multiple position control choose display
2020+37	08	0x0F70	RW	DEC	Multiple speed control choose display
2020+38	10	0x0F80	RW	ms	Multiple speed/position Switching delay

Table 9-14 Performance Objects

Canopen address	Bits	Modbus address	Command type	Unit	Description
6065+00	20	0x3800	RW	DEC	Max. following error at which the drive generates an alarm Default value 200inc
6067+00	20	0x3900	RW	DEC	Position reach window Position range for target reached Default value 10inc
607D+01	20	0x4410	RW	DEC	Soft positive limit

607D+02	20	0x4420	RW	DEC	Soft Negative limit
---------	----	--------	----	-----	---------------------

Table 9-15 Homing control

Canopen address	Bits	Modbus address	Command type	Unit	Description
6098+00	08	0x4D00	RW	DEC	Homing mode (refer to homing control mode)
6099+01	20	0x5010	RW	DEC=[(RPM*512 *60000)/1875]	Speed of searching limit switch
6099+02	20	0x5020	RW		Speed for searching homing signal
609A+00	20	0x5200	RW	DEC=[(RPS/S*65 536 *60000)/4000000]	Acceleration for searching homing
607C+00	20	0x4100	RW	DEC	Homing offset
6099+04	10	0x5040	RW	1Ap=1.414 Arms 1Arms=79dec	Homing current

Table 9-16 Input and output parameters

Canopen address	Bits	Modbus address	Command type	Unit	description
2010+03	20	0x0830	RW	Bit	Function definition of Digital input 1
2010+04	20	0x0840	RW	Bit	Function definition of Digital input 2
2010+05	20	0x0850	RW	Bit	Function definition of Digital input 3
2010+06	20	0x0860	RW	Bit	Function definition of Digital input 4
2010+07	20	0x0870	RW	Bit	Function definition of Digital input 5
2010+08	20	0x0880	RW	Bit	Function definition of Digital input 6
2010+10	20	0x0900	RW	Bit	Function definition of Digital output 1
2010+11	20	0x0910	RW	Bit	Function definition of Digital output 2
2010+12	20	0x0920	RW	Bit	Function definition of Digital output 3
2010+0B	10	0x08B0	RO	Bit	Input status bit0: Din1 bit1: Din2 bit2: Din3 bit3: Din4 bit4: Din5 bit5: Din6
2010+18	10	0x0980	RO	Bit	Output staus bit0: Dout1 bit1: Dout2

					bit2: Dout3
2010+01	10	0x0810	RW	Bit	Polarity of Input signal 0: closed; 1: open bit0: Din1 bit1: Din2 bit2: Din3 bit3: Din4 bit4: Din5 bit5: Din6 Default FF
2010+0E	10	0x08E0	RW	Bit	Polarity of Output signal 0: close; 1: open bit0: Dout1 bit1: Dout2 bit2: Dout3 Default value FF
2010+02	10	0x0820	RW	Bit	Signal Simulation of input bit0: Din1 bit1: Din2 bit2: Din3 bit3: Din4 bit4: Din5 bit5: Din6
2010+0F	10	0x08F0	RW	Bit	Signal Simulation of output bit0: Dout1 bit1: Dout2 bit2: Dout3
2020+31	08	0x0F10	RW	DEC	Input operation mode control 0 Without input mode
2020+32	08	0x0F20	RW	DEC	Input operation mode control 1 With input mode
2020+33	10	0x0F30	RW	DEC	Input control word

Table 9-17 Pulse input parameters

Canopen address	Bits	Modbus address	Command type	Unit	Description
6410+18	10	0x7180	RW	DEC	Numerator of pulses per revolution
2508+03	08	0x1930	RO	DEC	Pulse mode control 0... Double pulse mode

					1...Pulse direction mode 2...Incremental encoder mode Note: select pulse mode via IO
2508+04	20	0x1940	RW	DEC	Input pluses before electronic gear
2508+05	20	0x1950	RW	DEC	Input pluses after electronic gear
2508+06	10	0x1960	RW	DEC	Filter frequency of Pulse smoothing coefficient $f=1000/(2\pi * \text{Pulse_Filter})$ Time constant $\tau = \text{Pulse_Filter}/1000$ (S)
2508+0C	10	0x19C0	RW	kHz	Pulse frequency before electronic gear
2508+0D	10	0x19D0	RW	kHz	Pulse frequency after electronic gear
6410+18	10	0x7180	RW	Step/rev	The pulse number of motor per revolution

Table 9-18 Analog input parameters

Canopen address	Bits	Modbus address	Command type	Unit	Description
2502+0F	10	0x16F0	RW	DEC	Output data of analog 1
2502+01	10	0x1610	RW	DEC	Filter parameter and frequency of analog 1 $f=4000/(2\pi * \text{Analog1_Filter})$ Time constant $\tau = \text{Analog1_Filter}/4000$ (S)
2502+02	10	0x1620	RW	DEC	Analog 1 Dead DEC=Dead_Voltage/10V*8192
2502+03	10	0x1630	RW	DEC	Analog 1 offset DEC=Offset_Voltage/10V*8192
2502+14	08	0x1740	RW	DEC	Output polarity of analog 1
2502+13	10	0x1730	RW	RPM	10V Speed of analog
2502+07	08	0x1670	RW	HEX	Simulate-speed control 0: Invalid analog channel 1: Valid analog channel 1 (AIN1) 0x10 ~ 0x1f : AIN1“Control inside speed control section 【x-10】 ”

Table 9-19 Motor parameters

Canopen address	Bits	Modbus address	Command type	Unit	Description
6410+01	10	0x7010	RW	HEX	Select Motor type, formatting of the value is ASCII motor type select ASCI.....HEX....TYPE "00".....3030...no motor select "MC".....434d...self detect motor parameter "XX".....5858...customer write parameter "A1".....3141...2S42Q-03848

					"A2".....3241...2S42Q-02940 "B1".....3142...2S56Q-030B5 "B2".....3242...2S56Q-02976 "B3".....3342...2S56Q-02054 "B4".....3442...2S56Q-02741 "C1".....3143...2S86Q-069B8 "C2".....3243...2S86Q-05180 "C3".....3343...2S86Q-03865 "C4".....3443...2S86Q-051F6 "C5".....3543...2S86Q-030B8 "C6".....3643...2S86Q-03080 "C7".....3743...2S86Q-01865 "D1".....3144...2S110Q-054K1 "D2".....3244...2S110Q-047F0 "D3".....3344...2S110Q-03999 "E1".....3145...2S130Y-063R8 "E2".....3245...2S130Y-039M0 "F1".....3146...3S57Q-04079 "F2".....3246...3S57Q-04056 "F3".....3346...3S57Q-04042 "G1".....3147...3S85Q-04097 "G2".....3247...3S85Q-04067 "G3".....3347...3S85Q-040F7
6410+05	08	0x7050	RW	2p/r	Number of motor polarity is defaulted as 50
6410+0B	10	0x70B0	RW	1Arms=10dec	The motor phase current
6510+04	10	0x8040	RW	1Arms=10dec	The motor phase current limit
6410+0C	10	0x70C0	RW	1mH=10dec	The inductance of motor phase
6410+0D	10	0x70D0	RW	1Ω=10dec	The resistor of motor phase
6410+13	08	0x7130	RW	Dec	Direction of motor turn 0: clockwise 1: counter-clockwise
6410+16	10	0x7160	R	HEX	The value formatting of Current motor type is ASCII.
6410+19	08	0x7190	RW	DEC	Motor parameter with power on and self-test switch 0: Disable 1: Enable
6410+1A	08	0x71A0	RW	DEC	The phase of motor 2: 2 phase stepping motor 3: 3 phase stepping motor
6410+1B	08	0x71B0	RW	DEC	IO port with 5V voltage output switch 0: Disable 1: Enable

Table 9-20 Parameters for saving

Canopen address	Bits	Modbus address	Command type	Unit	Description
2FF0+01	08	0x2910	RW	DEC	1: Save all parameters updated 10: Initialize all parameters updated Note: save for control loop parameters, un-involves motor's
2FF0+03	08	0x2930	RW	DEC	Save motor parameters

					1: save all motor parameters updated
--	--	--	--	--	--------------------------------------

Table 9-21 Error code

Canopen address	Bits	Modbus Address	Command type	Unit	Description
2601+00	10	0x1F00	RO	Bit	Real-time alarm error lower to 16 bits Bit 0: internal bit 1: over current bit 2: over voltage bit 3: low voltage bit 4: Temperature bit 5: internal logic voltage bit 6: 5V input current overload bit 7: internal EEPROM bit 8: Searching Motor error bit 9: Position error bit10: Bus error bit 11: Input pulse frequent bit 12: -- bit 15:
2602+00	10	0x2000	RO	Without sign	Real-time alarm error over to 16 bits Bit 0: -- Bit 15:
2603+00	10	0x2100	RO	Bit	Self-test error status lower to 16 bit with power-on bit 0: A phase over current bit 1: B phase over current bit 2: high voltage bit 3: lower voltage bit 4: lower voltage power supply bit 5: temperature bit 6: A phase over current bit 7: B phase over current bit 8: A phase over current bit 9: B phase over current bit 10: A phase power circuit bit 11: B phase power circuit bit 12: Motor phase wrong wiring bit 13: Motor A phase wrong wiring bit 14: Motor A phase wrong wiring

					bit 15: Motor A phase without wiring
2604+00	10	0x2200	RO	Bit	Self-test error status up to 16 bits bit 0: Motor B phase without wiring bit 1: Analog input circuit bit 2: Logic 15V voltage bit 3: Logic 5V voltage bit 4: Output 5V overload bit 5: Memory read failure bit 6: Memory write failure bit 7: Memory read and write failure bit 8: Memory read data checking error bit 9: Reserved bit 10: Reserved bit 11: watch-dog reset bit 12: Reserved bit 13: Program does not match with the PCB bit 14: A crystal oscillator circuit fault bit 15: ADC Conversion circuit fault
2610+00	08	N/A	RO	Bit	Drive error group 0
2611+00	08	N/A	RO	Bit	Drive error group 1
2612+00	08	N/A	RO	Bit	Drive error group 2
2613+00	08	N/A	RO	Bit	Drive error group 3
2614+00	08	N/A	RO	Bit	Drive error group 4
2615+00	08	N/A	RO	Bit	Drive error group 5
2616+00	08	N/A	RO	Bit	Drive error group 6
2617+00	08	N/A	RO	Bit	Drive error group 7

Table 9-22 Bus specification parameters:

Canopen address	Bits	Modbus address	Command type	Unit	Description
100B+00	08	0x0600	RW	number	Station No. of drive Note: 1) ID station can be selected from SW6-SW1 as 1-16, or 0x2FE400 as 1-127 2) it need to reboot after updated.
2FE4+00	08	0x2800	RW	number	Drive station No. 1~127; Note: your setting is valid when SW6-SW1 on OFF. Then reboot it when you updated the parameters.

2F81+00	08	0x2300	RW	number	CAN baud rate setting default value is 50 Value baud rate 100: 1M 50: 500k 25: 250k 12: 125k 5: 50k Need to save and reboot
2FE0+00	10	0x2400	RW	number	RS232 baud rate setting default value is 259 Value baud rate 2082 4800 1041 9600 520 19200 259 38400 86 115200 Need to save and reboot
2FE2+00	10	0x2600	RW	number	RS485 baud rate setting default value is 520 value baud rate 1041 9600 520 19200 259 38400 86 115200 Need to save and reboot

Kinco

To be the partner of your success

Kinco Electric (Shenzhen) Ltd.

Address: 7/F, Bldg.9th, Software Park, Keji Central Road 2nd, Nanshan District, Shenzhen, China
(518057)

Tel: 86-755-26585555

Fax: 86-755-26616372

<http://www.kinco.cn>

Email: sales@kinco.cn